



**INSTRUCTIONS FOR INSTALLING
USE AND MAINTENANCE**

FASHION UPGRADE ESPRESSO

FASHION UPGRADE INSTANT

CODE C22608101

ISSUE 07 - 02/2010





Fas International S.p.A.
Via Lago di Vico, 60 - 36015 Schio (VI) ITALY
Tel. +39 0445.502011 - Fax +39 0445.502010
E-mail : info@fas.it

Cap. Soc. i.v. €. 7.000.000
Reg. Impr.Vicenza n. 02081960243
C.F. e P.I. 02081960243

Mod. 3.7.16
Rev. 00

**DICHIARAZIONE DI CONFORMITÀ - DECLARATION OF CONFORMITY
DECLARATION DE CONFORMITE - DECLARACION DE CONFORMIDAD
KONFORMITÄTSEKTLÄRUNG - DECLARAÇÃO DE CONFORMIDADE
DEKLARATION OM STANDARDDISIRING**

FAS INTERNATIONAL S.p.A.

Dichiariamo sotto la nostra responsabilità che il prodotto :
Declare under our responsibility that the product :
Déclare sous sa propre responsabilité que le produit :
Declara bajo propia responsabilidad que el producto :
erklären unter eigener Verantwortung, daß das Produkt,
Declara sob sua responsabilidade que o produto :
Bekendtgør på vort ansvar at nendennævnte produkt :

al quale questa dichiarazione si riferisce è conforme alle seguenti norme :
to which this declaration relates is in conformity with the following standards :
auquel cette déclaration se réfère est conforme aux normes suivantes :
objeto de esta declaración es conforme a los siguientes estándares :
auf das sich diese Erklärung bezieht, folgenden Normen entspricht :
objecto desta declaração está conforme as seguintes normas :
auf das sich diese Erklärung bezieht, folgenden Normen entspricht :

EN 60335-1 - EN 60335-2-75 - EN 62233

EN 55014-1 - EN55014-2 - EN 61000-3-2 - EN 61000-3-3

in base a quanto previsto dalle Direttive :
following the provisions of the Directives :
suivant les clauses des Directives :
seguiendo las clausulas de las Normas :
gemäß den Bestimmungen der Weisungen :
obedecendo ao clausulado das Normas :
Ifølge retningslinjer nedfældet i Direktiver :

2006/95 EEC Directive (Low Voltage Directive) and subsequent amendments

2004/108 EEC Directive (EMC Directive) and subsequent amendments

2006/42 EEC Directive (MACHINERY Directive) and subsequent amendments

Schio, 29 dicembre 2009

ADRIANI LUCA
AMMINISTRATORE DELEGATO

Le istruzioni, i disegni, le tabelle e quant'altro è contenuto nel presente fascicolo sono di natura tecnica riservata e, per questo, ogni informazione non può essere riprodotta né completamente né parzialmente e non può essere comunicata a terzi, senza l'autorizzazione scritta della FAS.

The instructions, drawings, tables and everything else contained in this pamphlet are of a confidential nature and, for this reason, no information can be reproduced wholly or in part, nor communicated to third parties without the written approval of FAS.





















Les instructions, les dessins, les tableaux et toute autre chose contenue dans le présent dossier sont des informations de nature technique confidentielle et pour cette raison, toute reproduction intégrale ou partielle de ces informations et toute communication de celles-ci à des tiers est formellement interdite, sans l'autorisation écrite de FAS.







Die Anleitungen, Zeichnungen, Tabellen und der restliche Inhalt dieser Akte sind technischer Natur und vertraulich. Deshalb dürfen sämtliche Informationen ohne schriftliche Zustimmung der FAS weder ganz noch teilweise vervielfältigt oder Dritten zugänglich gemacht werden.

Tanto las instrucciones como los dibujos, las tablas y todo lo demás contenido en el presente fascículo son de carácter técnico reservado y, por tanto, no se podrá reproducir ninguna información ni total ni parcialmente y no se podrá comunicar a terceros sin la autorización escrita de FAS.

BLANK PAGE FOR POSSIBLE NOTES

INDEX

1	INTRODUCTION	8
1.1	IN CASE OF FAILURE	8
1.2	GUARANTEE	8
1.3	SAFETY	9
1.4	EMERGENCY SITUATIONS	9
1.5	CONSULTATION GUIDE	10
2	GENERAL GUIDELINES	11
2.1	USE OF THE AUTOMATIC VENDING MACHINE	11
2.2	TRANSPORT AND STORAGE	11
2.3	UNPACKING PROCEDURE	12
3	INSTALLATION	13
3.1	DISINFECTING AND SANITIZING	13
3.2	CONNECTION TO THE POWER SUPPLY	14
3.3	CONNECTION TO THE WATER SUPPLY SYSTEM	14
3.4	MASTER / SLAVE CONNECTION  	15
3.5	WARNINGS FOR THE INSTALLATION  	15
3.6	INACTIVITY	15
3.7	WARNINGS FOR THE DEMOLITION OF THE MACHINE	15
4	"ESPRESSO" HYDRAULICS DIAGRAM	16
5	"INSTANT" HYDRAULICS DIAGRAM	17
6	TECHNICAL DATA	18
7	DOOR PARTS	19
8	INTERNAL PARTS	20
8.1	DOOR SWITCH	20
8.2	VMC BOARD AND POWER BOARD	21
8.3	BOILER AND AIR-BREAK	21
8.4	WATER INLET SOLENOID VALVE	21
8.5	COFFEE UNIT, COFFEE UNIT PRESENCE CONTROL	22
8.6	CUP CHECKING PHOTOCCELL (IF FORESEEN)	23
8.7	REPROGRAMMING DOOR LOCK	23
8.8	CLEANER / STENTENER (IF FORESEEN)	23
9	STARTING  	24
9.1	FILLING UP THE HYDRAULIC CIRCUIT  	24
9.2	LOADING THE CUPS  	25
9.3	STIRRER DISPENSER 	26
9.4	LOADING INSTANT PRODUCTS 	27
9.5	COFFEE BEANS LOADING 	28
9.6	INSERTING LABELS 	28
9.7	HOW TO INSERT THE COFFEE GROUNDS BAG 	28
9.8	LOCK ADJUSTMENT 	29
9.9	PAYMENT SYSTEM CONNECTION  	29
10	FUNCTION/PROGRAMMING KEYBOARD  	31
10.1	LIST OF PROGRAMME COMMANDS	32
10.2	LIST OF SERVICES ACCESSIBLE FROM COMMAND 52	33
10.2.1	ACCESS TO THE SUBMENUS	34
10.2.2	SETTING THE TEMPERATURE PARAMETERS	35
10.2.3	TO SET MACHINE PARAMETERS	37
10.2.4	TO SET MACHINE SLAVE PARAMETERS	43
10.2.5	SETTING THE CLOCK AND DAILY TIMERS	44
10.3	USING THE EXECUTIVE STD/EXECUTIVE PRICE HOLDING PAYMENT SYSTEMS	46
10.4	USE OF COINMECHANISM BDV 001	47
10.5	USE OF PAYMENT SYSTEMS MDB	49

11	CALIBRATION AND ADJUSTMENTS	51
11.1	ADJUSTING THE INSTANT BEVERAGES	51
11.2	ADJUSTING THE ESPRESSO COFFEE	51
11.3	ESPRESSO COFFEE CALIBRATION	51
12	HEALTH AND HYGIENE RULES	52
13	MAINTENANCE	52
13.1	GENERAL MAINTENANCE	52
13.2	BASIC MAINTENANCE 	53
13.3	SPECIAL PERIODIC MAINTENANCE.....	54
13.4	SPECIAL MAINTENANCE, CLEANING OF COFFEE UNIT FILTERS  	55
13.5	PROCEDURE FOR DRAINING AIR-BREAK AND BOILER WATER (SERVICE 16 AND 17).....	57
14	ALARMS  	58
15	TABLES FOR MACHINE MODEL CONFIGURATION (COMMAND 50)  	61

1 INTRODUCTION



This manual refers to models with espresso coffee units and instant coffee models: consequently, you may come across descriptions or explanations which do not refer to your particular machine.

This booklet is an essential part of the vending machine, therefore it must be kept with it for any moving or transfer of property so as to allow operators to make further consultations.



Before installing and use the vending machine, it is necessary to read this booklet carefully, as it provides important information regarding installation safety, use provisions and maintenance operations.

Installing and any further maintenance operation must be carried out by qualified assistance staff only.

This machine should be destined only to the use for which it has been expressly conceived. Any other use is to be considered improper.

REGISTRATION NUMBER PLATE

Each vending machine is identified by a specific registration number which is placed on the plate within the vending machine. This plate is the only one acknowledged by the manufacturer as the exclusive vending machine identification and it bears all data that give all technical information and allow an easy spare parts management. It is therefore **advised** not to damage or remove the means which are necessary for the identification of the product.

		
Schio (VI) Italy Via Lago di Vico 60		
Matricola/serial number		
Mod. / Model		
Anno / Year		
Tens. / Voltage	V	Hz
Potenza / Power	W	
Unità Refrigerante / Refrigeration unit		
Gas		
Classe-Tipo / Class-Type		
Pressione acqua/Water pressure MPa		

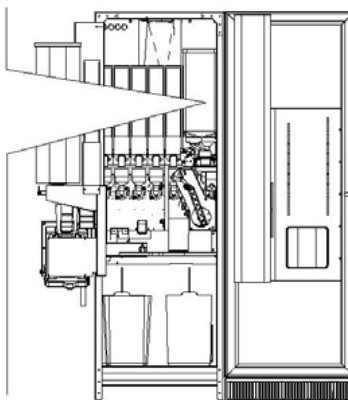

1.1 IN CASE OF FAILURE

In most cases, the possible technical problems are easily solvable with few intervention; therefore, we kindly suggest you to read this booklet carefully before consulting the manufacturer.

In case of anomalies or malfunctioning not easy to solve, you must fill in the "inconvenience or defectiveness reporting table" you will find within the vending machine and send it to the manufacturer :

FAS International S.p.A., Customer Service, Via Lago di Vico, 60 - 36015 Schio (VI) - Italy

Tel.: +39 0445 502011

Fax: +39 0445 502010

E-mail: info@fas.it

All requests regarding the vending machine must be with its registration number.

1.2 GUARANTEE

The builder guarantees its machines for 24 months for mechanical faults. Damages caused by a bad functioning of the machine, such as incorrect voltage, use of faulty coins, neglected cleaning, are not covered by this guarantee. Every technical intervention due to the bad use of the machine will beat the customer's charge.

1.3 SAFETY

	<p>This appliance is not intended for use by person (including children) with reduced physical, sensory or mental capabilities, or lack of experience and knowledge, unless they have been given supervision or instruction concerning use of the appliance by a person responsible for their safety. Children should be supervised to ensure that they do not play with the appliance.</p>
---	---





	<p>The use of accessories or components that are not original, endangers the safety of the machine. Fas declines all responsibilities because of the use of parts or accessories that are not original and is not accountable for whatever damages, direct or in direct, should result from such improper use. The variety of similar products that may be made available on the market, prevents FAS from a possible check on these components. Warning: the use of components and spare parts that are not original, may void the entire warranty on the machine.</p>
---	---

	<p>The vending machine construction and analysis relevant to safety issues refer to the requirements in force.</p> <p>The installation and maintenance procedures, including replacing the power supply cable, must be carried out by competent personnel.</p> <p>Any interventions other than routine maintenance procedures must be carried out with the plug of the power supply disconnected.</p> <p>It is obligatory to wear suitable clothing as stipulated in this manual and by the ruling in force in the country in which the machine is used; avoid wearing baggy or loose clothing, belts, rings and chains; long hair must be kept under a suitable cap.</p> <p>It is strictly prohibited to operate the machine with the fixed and/or mobile protections disassembled or with the safety devices switched off.</p> <p>It is strictly prohibited to remove or tamper with the safety devices.</p> <p>Do not perform machine maintenance operations or adjustments of any kind without first having read and familiarised yourself with the contents of this manual.</p> <p>Adjustment carried out with reduced safety protections or with some switched off must be performed by one person only: During the adjustments, access to the machine by non-authorised personnel must be prohibited. If possible keep only one protection open at a time.</p> <p>After having performed adjustments or maintenance operations with reduced safety protections, the machine must be restored as soon as possible to its original conditions with all the protections active.</p> <p>Comply rigidly with the periodical maintenance operations described in this manual to ensure safe working conditions and to maintain machine efficiency.</p> <p>Keep the safety labels in good condition and learn their significance: these are necessary for preventing accidents; if the labels are damaged, lost or belong to replaced parts, they must be replaced with other original labels which can be requested from the Manufacturer.</p> <p>Remember that an alert operator in good mental-physical conditions is the best assurance against accidents.</p>
---	--

1.4 EMERGENCY SITUATIONS

	<p>In the event of fire, do not direct jets of water against the machine as this could cause short-circuiting and result in accidents, even fatal, for persons nearby.</p>
---	---

1.5 CONSULTATION GUIDE

SYMBOL	MEANING	COMMENT
	DANGER	Indicates a danger, even mortal, for the User.
	WARNING	Indicates a warning or notes on key functions or useful information. Pay careful attention to those parts of the text indicated by this symbol. The maintenance personnel are requested to take a measurement value, check a signal, check the correct position of any machine element, etc. prior to performing a determined command or operation.
	ROUTINE MAINTENANCE	<i>By routine maintenance</i> , it is intended: the reloading operations, emptying out the coins, and the cleaning operations in the areas in contact with the food products.
	EXTRAORDINARY MAINTENANCE	<i>By extraordinary maintenance</i> , it is intended: the more complex maintenance operations (mechanical, electrical, etc.) in particular situations, or those agreed with the user which are not considered ordinary maintenance.
	RECYCLING	Obligation to dispose of the materials respecting the environment.



Pay particular attention to those parts of the text which are written in bold type, with larger letters or underlined as these are used to highlight particularly important operations or information.

The enclosed wiring diagrams are intended for use exclusively by specialised technical personnel authorised by the manufacturer to carry out extraordinary maintenance operations and checks.

	It is strictly prohibited to use the wiring diagrams to modify the machine.
---	--

Throughout the manual, when referring to the machine, the terms "at the front" or "front" indicate the door side while the terms "at the back" or "rear" indicate the other side; the terms "right" and "left" refer to the operator facing the front of the machine.

For each operation to be carried out on the machine, a level of expertise (see below) is given to indicate the persons qualified to perform the operation concerned.

Final user	Person without specific expertise able to perform the operations of purchasing and retrieving the product only by using the controls displayed on the machine or by following the instructions given on the display.
Ordinary maintenance operator	Person capable of carrying out the operations in the above point and, in addition, of operating on the machine following the instructions in this manual marked with the symbol 
Extraordinary maintenance operator	Person capable of carrying out the operations in the above points and, in addition, of operating on the machine following the instructions in this manual marked with the symbols   . In each case, the specialised technicians must also be capable of operating with the protections disabled and therefore in reduced safety conditions. Any operations to be carried out with the parts of the machine in movement and/or on live equipment must only be performed in exceptional cases and once the impossibility of operating in suitable safety conditions has been established. Access to these areas should be permitted only to persons with a practical knowledge and experience of the machine, particularly in matters of safety and hygiene.

2 GENERAL GUIDELINES



This section is for qualified assistance staff only

Before connecting the machine to the hydraulic and power system, it is recommended to :

- Read these instructions carefully, as they provide you with important indications relating to installation safety.
- Keep this booklet with care for any further consultation.
- **This machine has been conceived for indoor installation. It is therefore forbidden to install it outdoor.**
- The manufacturer cannot be held responsible for possible damages deriving from improper , wrong and unreasonable use.
- After having removed the packaging make sure that the machine is in good condition. If in doubt, do not use the machine, call directly the seller.
- The packaging (plastic bags, expanded polystyrene, nails, etc.) should be kept away from children, because it could become dangerous for them.

2.1 USE OF THE AUTOMATIC VENDING MACHINE

The automatic vending machine is intended to be used for dispensing beverages which are prepared by mixing foodstuffs with water (Instant coffee, instant chocolate, sugar, coffee in beam form, instant tea, instant barley, skimmed milk powder granules). Use only products which have been declared by the manufacturer as suitable for automatic vending in refillable canisters. The selections dispensed by the automatic vending machine must be consumed immediately and they must not be preserved or recycled for later use. Adhere strictly to the manufacturer's indications regarding the expiry date for each individual product.

2.2 TRANSPORT AND STORAGE

In order not to cause damages to the distributor, the loading and unloading manoeuvring have to be performed with particular care. The loading/unloading manoeuvres must be carried out by lifting the machine with a lifting truck, either motor-driven or manual, and by positioning the forks in the area under the pallet. To move the machine over short distances, for example inside a premises or office, the pallet need not be used. Proceed however with maximum caution to prevent damaging the machine. It is always **prohibited**:

- To lie the machine down;
- To turn the distributor upside down;
- To drag the distributor with ropes or similar;
- To lift the distributor from the side;
- To lift the distributor with whatever sling or rope;
- To shake the distributor and its packaging.

As to the storage of the machines, it is appropriate that the environment of conservation is very dry with temperatures between 1° + 40° C. Cover the machine after having positioned it in a protected environment and anchor it to prevent it from moving and to avoid accidental knocks.

It is **important** not to put one packed machine on the other and to maintain the vertical position shown by the arrows on the packaging itself.

2.3 UNPACKING PROCEDURE



Remember to remove packing materials or equipment inside the vending machine which could affect the correct function of the machine.

The packing material must be removed carefully to avoid damaging the machine. Inspect inside and outside the cabinet for any damage. Do not destroy the packing material until the manufacturer's representative has examined it.

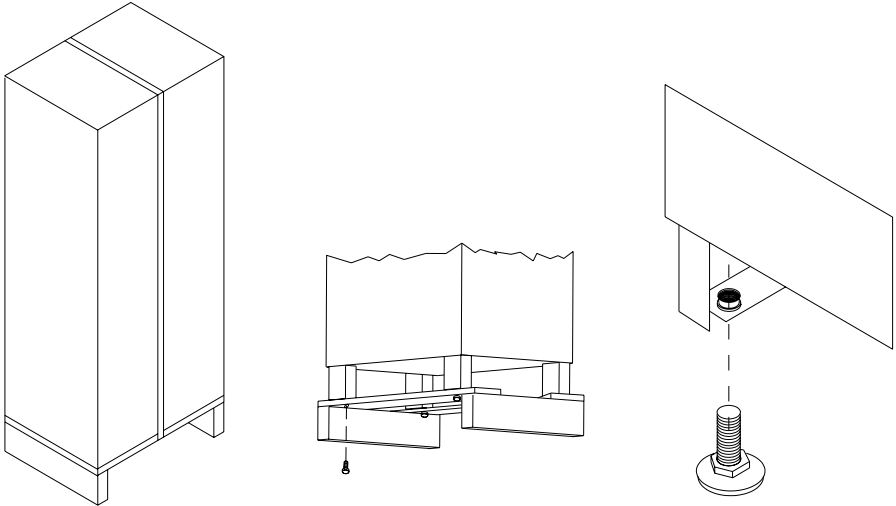

- Screw up the feet into their housings on the bottom of the machine. Adjust the feet with a leveller to have the machine perfectly horizontal.
- Open the machine door and remove the inside transport reinforcements. These parts are marked by specific signs inside the machine.
- **Before connecting the machine to the power supply make sure that data on the plate correspond to those of the electric and the water supply networks.**
- Do not cover with clothes or similar.



THE MANUFACTURER DISCLAIMS ALL RESPONSIBILITY FOR ANY DAMAGES CAUSED BY THE NON-COMPLIANCE WITH THE CAUTIONS DESCRIBED IN THIS SECTION

3 INSTALLATION



- Installation should be carried out by skilled staff in accordance with current regulations and manufacturer's instructions. Installation should also comply with CEI EN 60335-1 "Safety of household and similar electrical appliances.
- A faulty installation can cause damage to people, animals and things, for which the manufacturer cannot be held responsible.
- Electrical safety is guaranteed only if the machine is correctly connected to an effective earthed system installed in compliance with current safety rules. It is necessary to verify this essential safety condition. If in doubt ask skilled staff to control the whole system.
- The manufacturer cannot be held responsible for damages caused by missing earthed system.

The machine cannot be installed in places where the room temperature is not comprised between 5° and 35°C, in places that are not protected by atmospheric agents and in places where jets of water are used for cleaning.

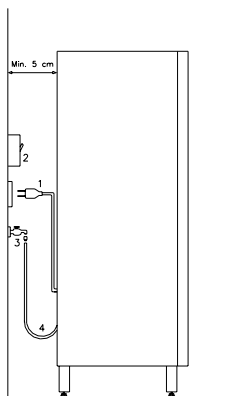

Description of connections

1. Plug "Schuko"
2. Power switch
3. Water tap
4. Water pipe

The vending machine must be installed on a surface (floor, intermediate floor) of suitable bearing capacity. Check that the power of the whole electrical system is adequate for the maximum power of the machine (see plate). The appliance must be connected to a power supply mains featuring earthing which complies with current legislation. The manufacturer recommends providing an electric power supply mains for the vending machine which is equipped with a disconnecting device having a contact opening of at least 3 mm. Ensure that the plug is accessible after installation. It is strictly forbidden to use extension cords, adaptors or multiple jacks.

When connecting the machine to the power supply, please take all instruction of this booklet into account.

In order to avoid dangerous overheating it is advisable to unwind the supply wire entirely.

Do not clog ventilation and dissipation grates.

All cleaning operations must be carried out after disconnecting power and water supply as described for previous operations.

Once connections have been made, the vending machine must be placed near to a wall so that its back has a minimum distance of 5 cm from the wall in order to allow a regular ventilation (connectors are part of the vending machine). Do not cover with clothes or similar.

The machine performs best at 10-32°C room temperature. Do not therefore install the machine near heat sources.

3.1 DISINFECTING AND SANITIZING

During the installation stage you must proceed with the total sanitization of the complete hydraulic circuit and of the parts in contact with the foodstuffs in order to eliminate every trace of bacteria which may have formed during storage. Also use sanitizing products (e.g. chloro detergents) for cleaning inside the vending machine, complying scrupulously with the doses specified on the label. Do not use detergents which are too "aggressive" as they could damage some of the parts. The manufacturer declines all responsibility for damage caused by the improper use of such detergents or the use of toxic agents.

3.2 CONNECTION TO THE POWER SUPPLY

When using a kind of electric device always keep some general essential rules in mind. Particularly:

	<ul style="list-style-type: none"> • never touch the machine if you have damp or wet hands or feet; • never activate the machine when you are barefoot; • do not use extension wires in rooms used as bathrooms or showers; • do not pull the supply wire in order to disconnect the machine from the power supply. • Before carrying out any cleaning or maintenance operation always disconnect the machine from the power supply by turning the switch off. • The machine is nevertheless provided with an onnipolar switch, which deactivates power supply when the door is open. • If you need to adjust some parts of the machine in operation, power supply can be restored by turning the special key. This operation may only be carried out by skilled staff, trained for maintenance of the machine. • The key is given to qualified assistance staff only. • When the door is open, the protected terminal box of the supply cable and the cables which connect it to the door safety switch are in tension. The whole isolation from the power supply is obtained only turning the external switch off.
---	---

In case of a breakdown and/or poor functioning of the machine switch it off and close the water tap without making any attempt to repair it.

Apply only to skilled staff.

The machine may be repaired by skilled staff only. Original spare parts only are to be used.

A lack of compliance with the mentioned rules could jeopardize machine safety.

3.3 CONNECTION TO THE WATER SUPPLY SYSTEM

	<p>Only cold water intended for human consumption (drinking water) must be fed into this vending machine. The microbiological properties of the water intended for human consumption are specified in European Directive 98/83/EEC, or comply with applicable federal, state or local laws. Check that at the water inlet point of the vending machine:</p> <ul style="list-style-type: none"> • The pH level conforms to laws in force; • The chlorine level is below 100mg/l; <p>If the values do not fall within these limits, a special water treatment device (in observance of local regulations in force) must be installed. If the water hardness exceeds 8°F (4.5 °D) a specific maintenance schedule must be drawn up in relation to the hardness level in order to ensure that the machine functions correctly.</p>
---	--

The operating pressure must range between 0.1 and 0.8 MPa. For the installation use only the parts supplied; if you need to use other parts, use only new parts (never used previously) that are suitable for contact with water intended for human consumption (in compliance with local regulations in force).

A tap must be installed between the water mains outlet and the vending machine delivery tube so that the passage of water may be closed off if necessary. Connect the water delivery tube to the fitting (¾ gas) that is already installed at the back of the vending machine as indicated. Screw it securely in place but without exerting excessive force which could crack the fittings.

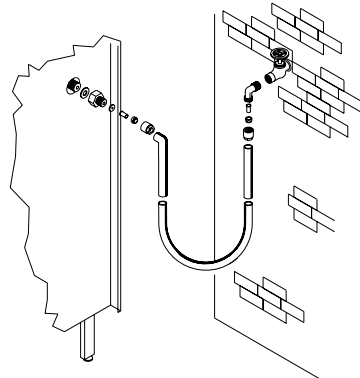

3.4 MASTER / SLAVE CONNECTION

Up to two SLAVE machines (FAST FULLVIEW or FASTER FULLVIEW) can be connected to the MASTER machine. A serial cable is used for each connection, and the connectors are accessible from the rear of the machine. Either one of the connectors indicated by the arrows can be used for the MASTER/SLAVE connection.

Optional NOT available on the "R" (reinforced) version.

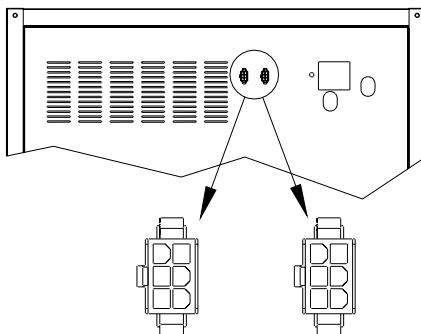

3.5 WARNINGS FOR THE INSTALLATION

The machine is sold without payment system. Therefore whatever default to the machine or damages to person or things due to an incorrect installation, use or similar caused by the payment system will be only and exclusively charged to those who have carried out the installation of the machine.



After the installation procedure is completed, never store the safety switch key inside the vending machine. The installer must take possession of the interlock key. The interlock key must only be consigned to qualified assistance service personnel. Once the qualified assistance service technician has completed the required operations as described in this manual he must always remove the key from the vending machine, in order to prevent the loader from using it.

3.6 INACTIVITY

If long periods of machine inactivity are expected, it is recommended to adopt adequate precautions to prevent dangerous situations when the machine is re-started.

For long resting period, it is necessary:

- To empty out the hydraulic circuit completely;
- To empty out all the products from the canisters;
- To empty out the coffee grinder-metering unit;
- To clean the machine thoroughly and to dry it;
- To check carefully for damaged or worn parts and to replace them;
- To check that the screws and bolts are securely tightened;
- To cover the machine after having stored it in a protected environment.

To re-set the machine at work, comply with the instructions given in the paragraph "Installation" of this manual and pay particular attention if food products are to be sold (see paragraph "INSTALLATION").

3.7 WARNINGS FOR THE DEMOLITION OF THE MACHINE



If the machine is disassembled in order to be definitively demolished, it is obligatory to follow the rules in force regarding the protection of the environment. All ferrous, plastic or similar materials should be taken to the authorized depots. Disposal in compliance with EU 2002/96/EC standards, according to the implementation of the Directive into the national law. This equipment complies with Directive 2002/95/EC (RoHS).

Should you have any queries, you are recommended to contact competent local refuse disposal authorities.

4 "ESPRESSO" HYDRAULICS DIAGRAM

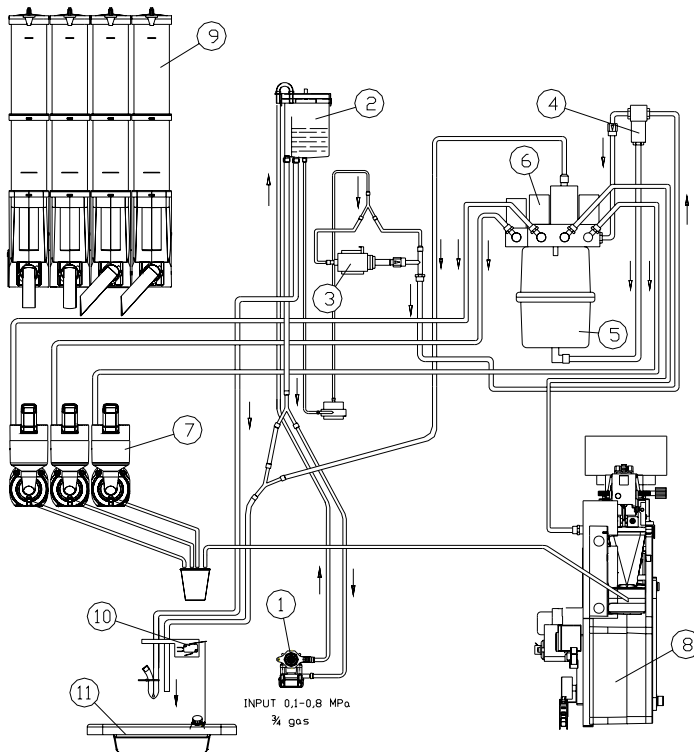

Key:

1. water inlet solenoid valve
2. air-break
3. espresso pump
4. mixing solenoid valve
5. espresso boiler
6. delivery solenoid valve
7. mixer
8. espresso unit
9. product containers
10. waste micro
11. liquid grounds tray

5 "INSTANT" HYDRAULICS DIAGRAM

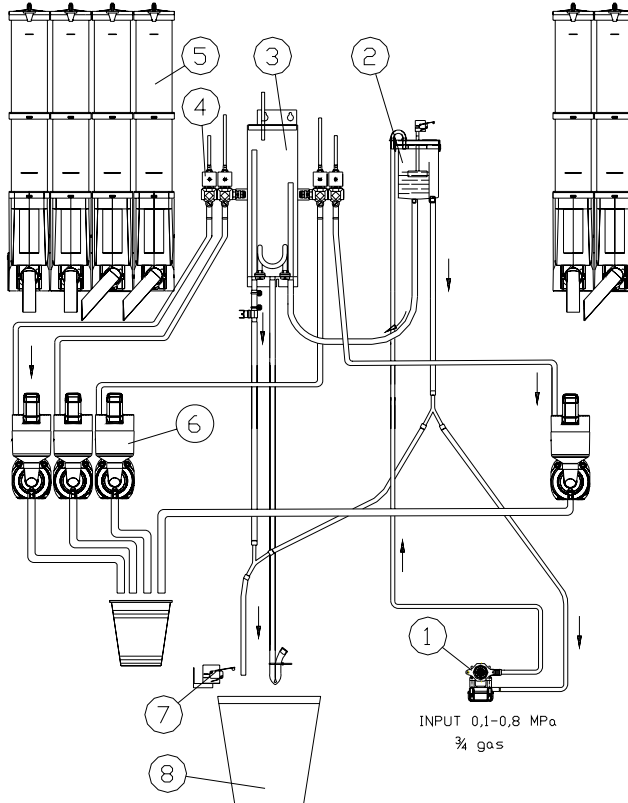

Key:

1. water inlet solenoid valve
2. air-break
3. instants boiler
4. delivery solenoid valve
5. product containers
6. mixer
7. waste micro
8. liquid grounds tray

6 TECHNICAL DATA

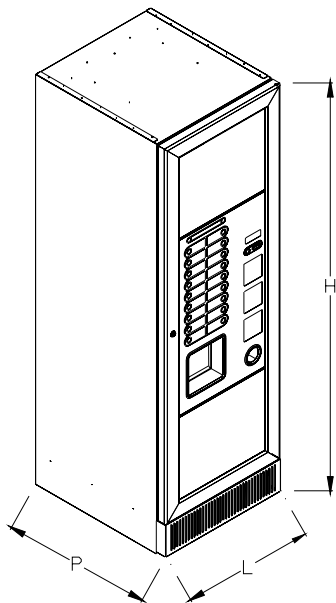

Machine dimensions

Height	H = mm 1830
Width	L = mm 600
Depth	P = mm 690
Weight	Kg 130
Weight	Kg 140 ("R" version)

Electrical Data

Rated Voltage	see identification plate
Rated power	see identification plate

Water supply

from network (inlet pressure)	MPa 0,1 - 0,8
Pipe fitting	¾ gas

Weighted sound pressure level "A"





less than 70 dB

Cup dispenser and stirrers

diam. 70mm	600 cups
stirrers	585

Safety

Door switch.
Manual reset water heater safety thermostat.
Waste level reached.
Thermal protection of all gear and mixer motors.

	Canister 75	Large canister	Small canister	Coffee bean hopper
Canisters capacity				
Milk (Kg)	1,2	1,7	n.c. ⁽¹⁾	n.a. ⁽¹⁾
Chocolate (Kg)	3,0	4,0	n.c. ⁽¹⁾	n.a. ⁽¹⁾
Tea (Kg)	3,1	n.c. ⁽¹⁾	2,7	n.a. ⁽¹⁾
sugar (Kg)	3,7	4,8	n.c. ⁽¹⁾	n.a. ⁽¹⁾
Instant coffee (Kg)	1,0	n.c. ⁽¹⁾	0,8	n.a. ⁽¹⁾
Coffee beans (Kg)	n.a. ⁽¹⁾	n.a. ⁽¹⁾	n.a. ⁽¹⁾	4,0

The actual quantity for each canister can differ from the indicated values depending on the specific weight of the products contained in it.

⁽¹⁾ Key:

n.a. = not applicable

n.c. = not advised

7 DOOR PARTS

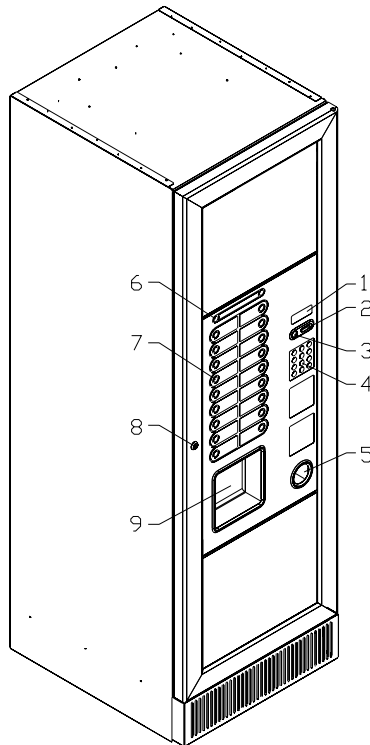

- 1 **Display:** The total of the coins inserted in the slot, the selection reference, the price of the selection and all the operating messages appear on the display. If there is a problem with the vending machine the number of the current alarm appears on the display.
- 2 **Coin slot:** the customer inserts the credit required to purchase the product in this slot.
- 3 **Coin return button:** this push button is used to release any coins jammed in the coin mechanism and return them to the coin return cup.
- 4 **Slave selection push button panel:** is situated under the coin return push button and consists of a series of switches identified by letters and numbers. To select a slave machine (if connected), enter the code which corresponds to the desired product (ex. A11).
Optional NOT available on the "R" (reinforced) version.
- 5 **Coin return cup:** is located on the lower part of the machine; the customer collects change from this cup.
- 6 **Sugar preselection:** the extra sugar or no sugar options are activated from the panel.
- 7 **Direct selection keypad:** The keypad consists of 18 "membrane" keys for the preselections and the selections. The keys assume different functions when the vending machine is in the programming mode; these functions are indicated next to each key.
- 8 **Door lock.**
- 9 **Delivery door:** is used by the customer to collect the purchased product.

8 INTERNAL PARTS



This chapter is for qualified assistance staff only

8.1 DOOR SWITCH

Opening the door, a safety switch cuts the power supply to the machine. To give tension to the machine with the door opened, it is sufficient to put the key in the slot.

It is possible to close the door only after having removed the key from the slot.

The key is given to qualified assistance staff only.



When the door is open, the protected terminal block of the power cable and the wires which connect it to the door safety switch are live. Complete insulation from the electricity mains is only obtained by turning off the external switch. Therefore all the operations which require the vending machine to be powered with the door open must be carried out only by qualified personnel informed of the specific risks which this condition entails.

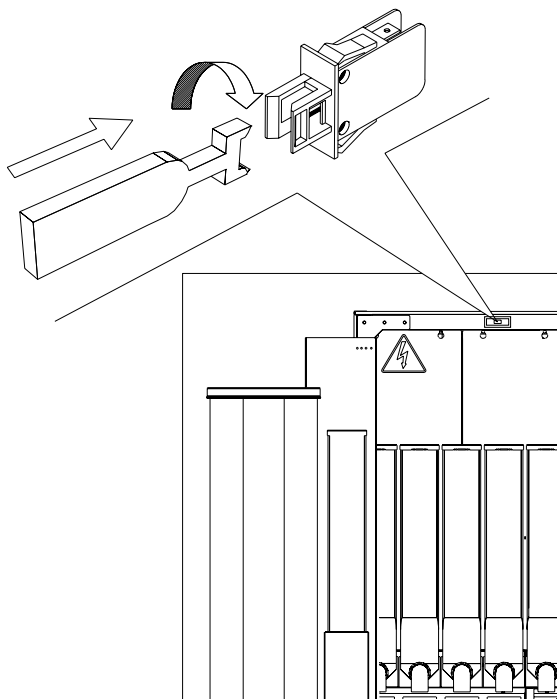

8.2 VMC BOARD AND POWER BOARD.

The VMC board is where the vending machine's central command and control unit (CPU) resides. It is installed inside the vending machine door, protected by the coin mechanism support door. This board houses the connectors used for connecting the payment systems and the connector for the infrared transmitter for audit data acquisition. The major protocols for coin mechanisms are used.

The power board controls the vending machine's actuators and the boiler temperature. It is installed inside the electric panel which is located behind the instant product canisters.

8.3 BOILER AND AIR-BREAK

ESPRESSO MODELS.

The pressure boiler has a capacity of 650cc. and it is fitted internally with a 1450W heating element.

The manufacturer calibrates the working temperature so that the temperature of the water dispensed at the coffee solenoid outlet is approx. 90°, whereas for the instant selections the mixer solenoid valve ensures that the water temperature is approx. 75°.

The water level in the air-break is controlled by a level sensor.

A vibration pump, which dispenses the amount of water programmed for each selection (controlled by the volumetric counter), is installed between the boiler and the air-break.

INSTANT MODELS.

The non-pressure stainless steel boiler has a 2 litre capacity. It is heated by means of an 1800W immersion heating element, driven by a feeler which is controlled by the thermostat board. The manufacturer calibrates the working temperature to obtain water at the solenoid outlet dispensed at a temperature of approx. 80° degrees.

The water level in the boiler is controlled by a ball float which activates a microswitch in the plastic container (air-break) installed next to the boiler.

8.4 WATER INLET SOLENOID VALVE

The water inlet solenoid valve, located on the back of the vending machine, can be accessed from inside by removing the covering plate behind the canisters. It is fitted with a mechanical device which automatically stops the water from entering in the event of a problem with the solenoid valve or the water circuit.

To reset normal operation, proceed as follows:

- switch off the machine by means of the main switch;
- pull out and empty the overflow tube "A"; try not to spill the contents inside the machine;
- Close the water mains cock outside the vending machine.
- Loosen the union which fastens the water supply tube to the solenoid valve in order to release the residual pressure, then re-tighten.
- Reinsert the tube "A" in its position, open the water supply cock and reconnect the electrical power.

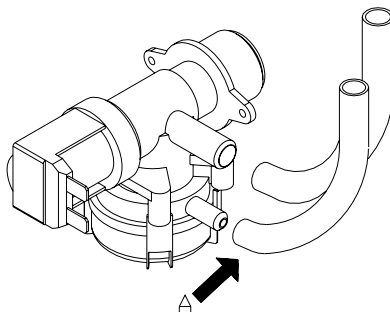

8.5 COFFEE UNIT, COFFEE UNIT PRESENCE CONTROL

Infusion chamber is driven by a gear motor (MRGC) through a joint.

Cams CRG - CPP set the working position of the unit during the coffee cycle, particularly:

- CRG = motor feeding
- CPP = motor stop in stand/dispensing position, start of infusion pump, opening solenoid valve coffee.

The functioning of the coffee unit is managed by a bottom (CPGC) that reads its presence in the support: if the coffee unit is installed, it works properly otherwise the following functions are inhibited:

- Service function for the coffee unit feed
- Service function for rinsing cycle for coffee unit
- Service function for coffee grinding
- Service function for grinded coffee dosage
- Inhibition of all the selections for espresso coffee + instant

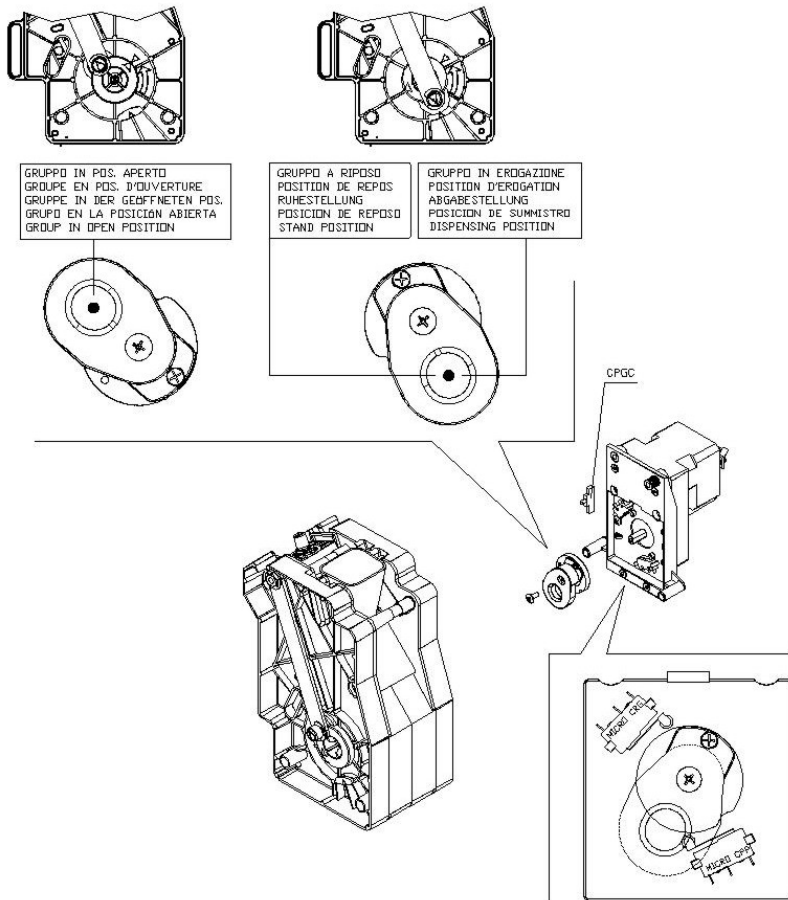

8.6 CUP CHECKING PHOTOCELL (IF FORESEEN)

The vending machine could be equipped with a cup checking photocell.

The grill can be set at three different positions in order to adapt the height of the compartment to the dimensions of the cup. To remove the grill turn the two side levers outwards and slide out the grill.

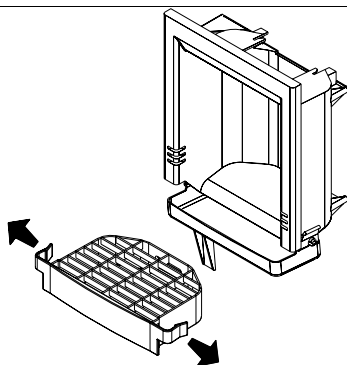

8.7 REPROGRAMMING DOOR LOCK.

Several versions are provided with a variable combination lock.

The lock of your vending machine can be customised using the special kit to change the combination.

To change the combination:

- Insert the old gold key and turn it by 120°. This brings the cylinder to the unprogrammed position. Remove the key.
- Insert the new gold key to change the combination. Turn it to the closed position (0°). The lock has been changed.

For normal opening /closing do not use the gold key as it could damage the lock; use the silver key.

To purchase the kit contact the area sales manager.

8.8 CLEANER / SOFTENER (IF FORESEEN)

The vending machine is not equipped with a cleaner/softener. In case of hard water it is necessary to put a cleaner/softener that has a capacity according to the machine consumption.

The cleaner/softener (available as an accessory) shall be restored periodically according to the manufacturer's indications.

9 STARTING

	<p>When the door is open, the protected terminal block of the power cable and the wires which connect it to the door safety switch are live. Complete insulation from the electricity mains is only obtained by turning off the external switch. Therefore all the operations which require the vending machine to be powered with the door open must be carried out only by qualified personnel informed of the specific risks which this condition entails.</p>
---	---

When the vending machine is turned on with the insertion of the associated key in the door switch, it carries out a cycle of movement of the spout mechanism and coffee unit.

9.1 FILLING UP THE HYDRAULIC CIRCUIT

Espresso models:

When the special key is inserted in the safety switch, the vending machine fills the air-break and consequently the boiler with water. It takes approx. 2 minutes for the water to reach the operating level. To ensure that the boiler is full of water, execute a number of washing cycles of the instants and check that the water discharge from the dispensing spouts is normal.

At the end of this operation, switch off the vending machine by removing the special key from the door switch, connect the power supply connector for the boiler heater to the board of the electric panel (JP11 connector). Switch the machine on again and wait for the water to reach the minimum operating temperature (approx. 10 minutes).

If the temperature of the water in the boiler drops below the minimum operating temperature, the vending machine goes temporarily out of order.

Instant models:

When the special key is inserted in the safety switch, the vending machine fills the air-break and consequently the boiler with water. If the water does not flow correctly from the air-break to the boiler, press and release the connecting tube in order to eliminate any air that may be present in the circuit. It takes approx. 2 minutes for the water to reach the operating level. To ensure that the water level in the boiler is the same as in the air-break, execute a number of washing cycles of the instants and check that the water discharge from the dispensing spouts is normal.

At the end of this operation, switch off the vending machine by removing the special key from the door switch, connect the power supply connector for the boiler heater to the board of the electric panel (JP11 connector). Switch the machine on again and wait for the water to reach the minimum operating temperature (approx. 10 minutes).

If the temperature of the water in the boiler drops below the minimum operating temperature, the vending machine goes temporarily out of order.

9.2 LOADING THE CUPS

Insert the centring rod on the cup dispenser (det.1). Then insert the cup holder (det.2). Use only vending machine cups with an outer edge diameter of 70 mm or 73mm. To adjust the cup holder diameter on the dispenser move the lever "A" as shown in the figure.

To prevent the vending machine from malfunctioning, before loading the cups check that they are not damaged or squashed into each other.

Turn off the vending machine by removing the key from the door safety switch, remove the cover from the cup holder and start by inserting the cups in the column immediately to the left of the cup dispenser outlet, and proceed in a counter clockwise direction.

Insert the key in the door safety switch and the cup holder rotation ratiomotor will rotate until the cups are correctly positioned in the dispensing seat.

If using cups with a 73 mm diameter, slide the cup chute out from the back by pressing the two levers "B" and remove the reducers "C" inserted in the cup chute.

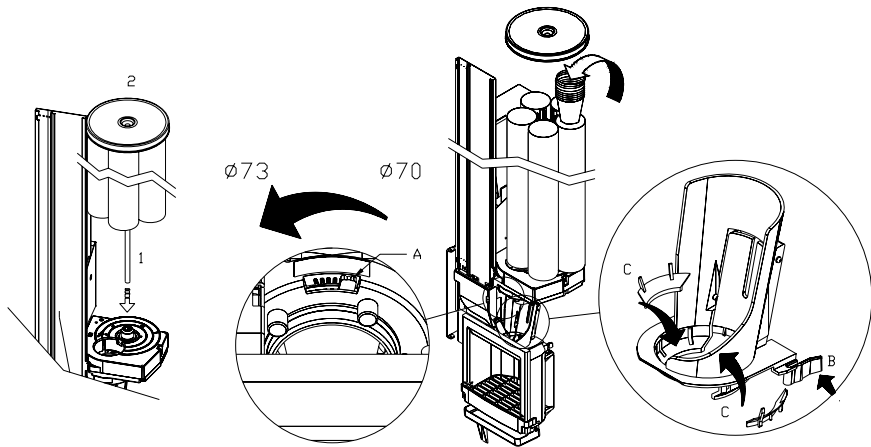

Use only vending machine cups with an outer edge diameter of 70 mm or 73mm. To adjust the cup holder diameter on the dispenser move the lever "A" as shown in the figure.

To prevent the vending machine from malfunctioning, before loading the cups check that they are not damaged or squashed into each other.

If using cups with a 73 mm diameter, slide the cup chute out from the back by pressing the two levers "B" and remove the reducers "C" inserted in the cup chute.

9.3 STIRRER DISPENSER

Shift the movable guide "A" by removing the screws that secure it to adapt it to the length of the stirrers. Remove the weight from the stirrer dispenser and load the stirrers into the c-shaped holder making sure that they are all laying flat and in a horizontal position. Make sure that there are no defective stirrers or stirrers with burrs. Once the stirrers have been loaded replace the weight on top of them.

To adjust the outlet to suit the thickness of the stirrers, remove the cover by pressing lever "B" indicated by the arrow, loosen screw "C" and rotate lever "D" until you obtain the optimal position.

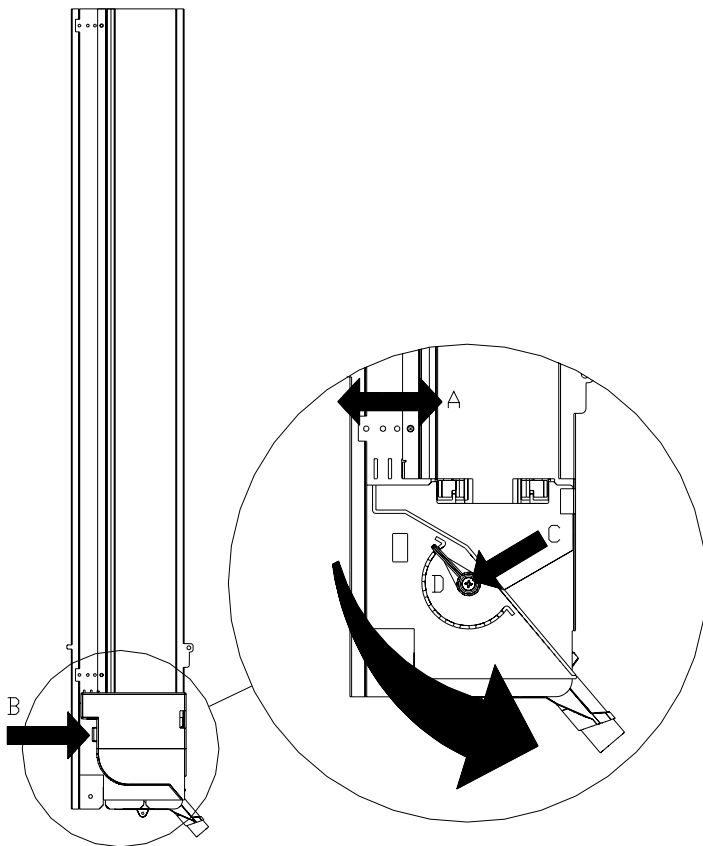

9.4 LOADING INSTANT PRODUCTS

The automatic vending machine is intended to be used for dispensing beverages which are prepared by mixing foodstuffs with water (Instant coffee, instant chocolate, sugar, coffee in beam form, instant tea, instant barley, skimmed milk powder granules). Use only products which have been declared by the manufacturer as suitable for automatic vending in refillable canisters. The selections dispensed by the automatic vending machine must be consumed immediately and they must not be preserved or recycled for later use. Adhere strictly to the manufacturer's indications regarding the expiry date for each individual product.

In the spare parts kit you will find the labels to apply to each canister indicating the name of the product contained inside it (Pos.1). Apply the same label to the canister support bracket (Pos.2) to ensure that the canisters are returned to the correct position once they have been filled up.

Apply the "MAX" label to indicate the required level for correct operation approximately 4 cm from the top edge or next to the top reinforcement of each canister.

The procedure for loading the products is as follows:

- Open the vending machine door .
- Lift up the cover of the canister to be filled up (Pos.3).
- Load the product taking care not to exceed the maximum level and make sure there are no lumps in the powders. Do not press the powder into the canister.
- Replace the cover.

To completely remove the canister:

- Open the vending machine door.
- Turn the dispenser union elbow located on the outlet hole of the canister upwards.
- Push and lift the container at the front to release it from the check pins placed on the front of the canister.
- Remove the canister by pulling it outwards.

In any case, after having poured the product into the canister, return the canister to its seat with the dispenser union elbow in its original position.

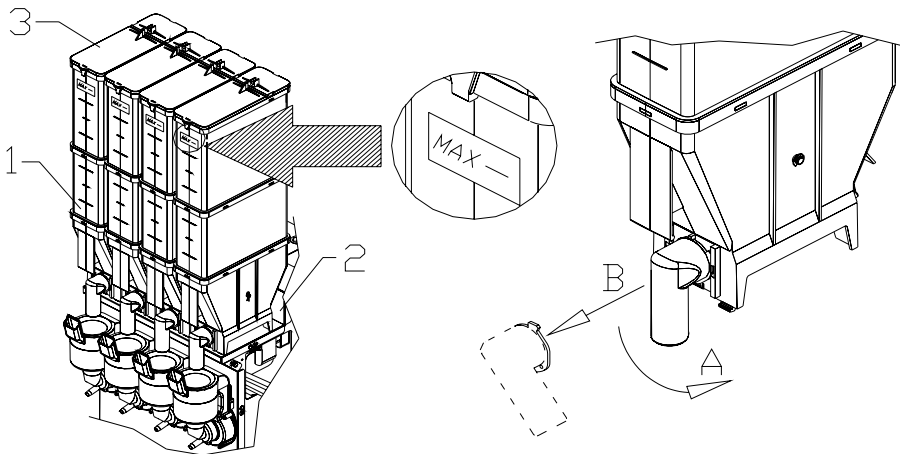

9.5 COFFEE BEANS LOADING

Apply the "MAX" label to indicate the required level for correct operation at approximately 4 cm from the top edge.

The procedure for loading the coffee beans is as follows:

- Lift off the lid of the coffee bean hopper (pos.1).
- Pour in the coffee beans (pos.2).
- Do not exceed the maximum level line.

It is not necessary to remove the bean hopper in order to fill it up.

To remove the bean hopper completely, proceed as follows:

- Slide locking flange of the bean hopper downwards (pos.3).
- Lift up the hopper and remove it.

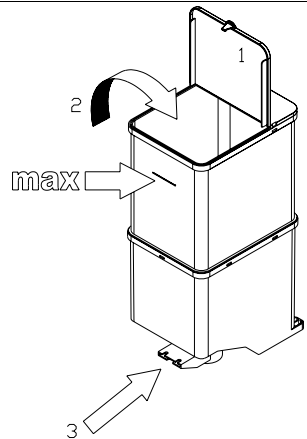

9.6 INSERTING LABELS

To insert the labels for the selections, remove the protection plate by loosening the fastening screws. Lift the plate a little then remove it completely. Insert the labels in the special slots. Before replacing the protection plate, check that the labels are in the correct positions.

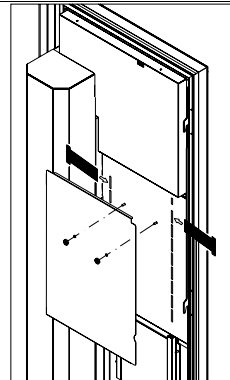

9.7 HOW TO INSERT THE COFFEE GROUNDS BAG

Remove the coffee grounds conveyor from the thermoformed tray. Insert the plastic bag on the tray hole, wrap it around the coffee grounds conveyor and return the conveyor to its seat.

Use bags which are long enough to reach the bottom of the vending machine.

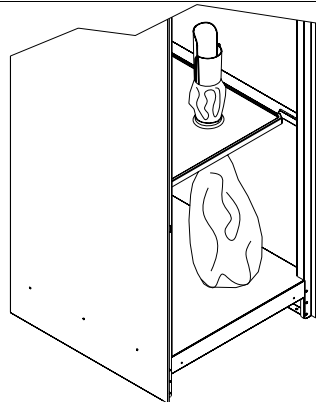

9.8 LOCK ADJUSTMENT

After having positioned the vending machine and adjusted the feet so that it is perfectly level, if necessary, loosen the screws which fix the movable plate and adjust it until the door closes perfectly.

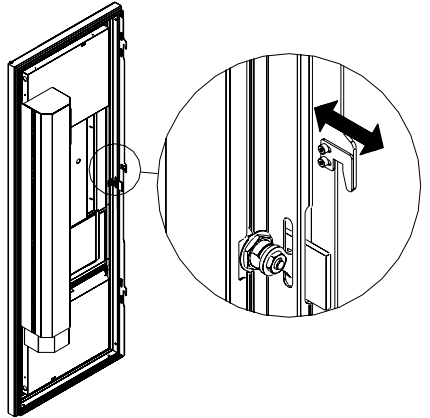

9.9 PAYMENT SYSTEM CONNECTION

The coin mechanism must be connected and disconnected with the machine switched off.

The connectors required to connect the coin mechanism are located next to the main board. The vending machine is set up for payment systems with EXECUTIVE, MDB and BDV protocols.

- Fasten the coin mechanism on the support between the two pins.
- Connect the coin mechanism connectors to the machine.
- Adjust the coin chute on the coin mechanism opening
- Adjust the coin return button leverage

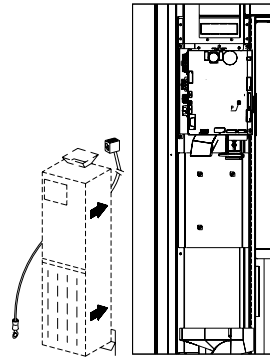

BLANK PAGE FOR POSSIBLE NOTES

10 FUNCTION/PROGRAMMING KEYBOARD



This chapter is for qualified assistance staff only

A six-key membrane keypad is installed on the side of the coin mechanism door. Starting from the top key, they have the following functions:

- 1 Programming Button
- 2 Test Vend Button
- 3 Sequential Washings Button
- 4 Cup Dispensing Button
- 5 Stirrer Dispensing Button
- 6 Cup/sugar/stirrer/arms disabled.

To use the membrane keypad insert the key in the safety switch and press the desired function key once.



When the door is open, the protected terminal block of the power cable and the wires which connect it to the door safety switch are live. Complete insulation from the electricity mains is only obtained by turning off the external switch. Therefore all the operations which require the vending machine to be powered with the door open must be carried out only by qualified personnel informed of the specific risks which this condition entails.

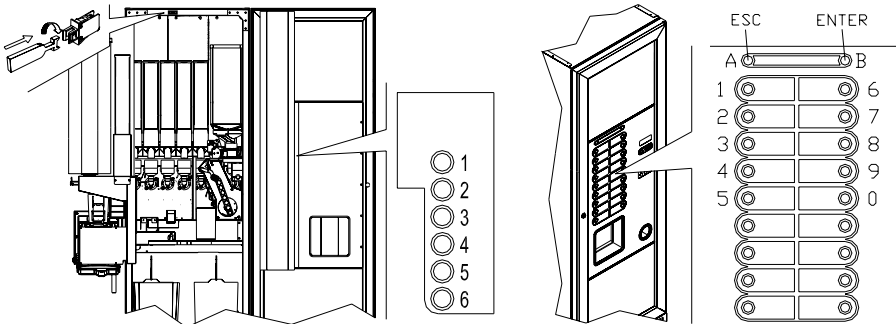

Programming Button: once programming is accessed, **Command 00** appears on the display. Direct access is possible from this main menu to several data or other submenus. Enter the command on **Direct selection keypad** and press **key B (ENTER)** to confirm the selection.

Key **B** is also used to confirm and memorise data inserted through the keyboard; in this case the text message **"OK"** appears on the display for a few seconds. To exit the programming or to go from a submenu to a main menu simply press **key A (ESC)**.

Test Vend Button: simply press this button to test the functionality of the vending machine. All the selections can be tested during this phase. At the end of the test, simply press the same button a second time to return to normal operation. The "TEST VEND" function is also used to display any alarms existing in the machine. Press the "B" (ENTER) key to scroll the list (if one exists) and at the end a message appears asking : "CLEAR DATA?". Press "B" (ENTER) to confirm and to eliminate all the alarm conditions, otherwise press "A" (ESC).

10.1 LIST OF PROGRAMME COMMANDS

ACCESS TO SUBMENUS

Command 02	Calls submenu for setting the clock & daily timers
Command 03	Recall of price setting submenu
Command 04	Calls submenu for setting discounted prices
Command 05	Recall the price reference setting submenu
Command 06	Setting the product code
Command 07	Display of sales for full price selection
Command 08	Displays sales for selection discounted price
Command 09	Displays totals cashed not clearable
Command 10	Displays totals clearable

COMMANDS 27÷39

Mode EXECUTIVE	<i>not used.</i>
Mode BDV	<i>see paragraph BDV.</i>
Mode MDB	<i>see paragraph MDB.</i>

SETTING THE TEMPERATURE PARAMETERS

Command 40 (**)	Select refrigeration unit type on SLAVE
Command 41	Set the temperature
Command 43 (***)	Set the temperature at the end of defrosting : (only slave machine)
Command 44 (**)	Set the defrosting frequency: (only slave machine)
Command 45 (**)	Setting the cut-out duration for the refrigeration safety device
Command 46 (**)	Setting the trigger temperature for the refrigeration safety device
Command 48 (**)	Setting trays with refrigeration safety device

TO SET MACHINE PARAMETERS

Command 49 (**)	Enable/disable slave spirals
Command 50	Setting machine model
Command 51	Set the recipe doses
Command 52	Recall services submenu
Command 53	Sugar quantity /Fresh Brew dose settings
Command 54	Presence of optional kits
Command 55	Setting the espresso coffee instant grinding
Command 56	Activation of the prompt change function
Command 57	Cup holder stop delay setting
Command 59	Stroke counter
Command 60	Erases the memory
Command 61	Reset security/access code
Command 62	Enable discount
Command 63	Set the mono/multivend
Command 64	Sets the message display language
Command 67 (**)	Display of spiral slaves temperature
Command 68	Setting displayed currency description
Command 69	Chooses functioning mode of the coin mechanism
Command 70	Buzzer operation option
Command 80	Cloning
Command 81	Fetch vend data
Command 85	Display of checksum and main and power board software version.
Command 90	Select AUDIT protocol
Command 91	Enter machine identification data
Command 92	Clear sales data
Command 93 (**)	Displays the temperature status over the last 24 hours
Command 94	Displays the last 10 power-offs
Command 95	Enter user message 1 (max 63 characters)
Command 96	Enter user message 2 (max 63 characters)
Command 97	NOT USED
Command 99	View error events

(**) Optional NOT available on the "R" (reinforced) version.

TO SET MACHINE SLAVE PARAMETERS ()**

- Command 73 (**)** Enabling the photoelectric cells FAST FULLVIEW
- Command 74 (**)** Photocell test FAST FULLVIEW
- Command 75 (**)** Setting the operating parameters of the photocell barrier FAST FULLVIEW
- Command 76 (**)** System's operating options ("FTC Options ") FAST FULLVIEW

SUBMENU FOR SETTING THE CLOCK & DAILY EVENT TIMERS (SEE COMMAND 02)

- Alarm set 01** Sets the year/month/day
- Alarm set 02** Sets the hour and minute
- Alarm set 10** Lighting control setting
- Alarm set 11÷14** Lights on/off
- Alarm set 21÷24** Setting the discount time slots
- Alarm set 31÷34** Selections disabled for daily time periods
- Alarm set 36** Setting the selections with timed disabling
- Alarm set 41** Sequential washing times setting

10.2 LIST OF SERVICES ACCESSIBLE FROM COMMAND 52

Service 00	Display boiler temperature
Service 01	Glass delivery cycle
Service 02	Mixer wash cycle 1 (first on the left)
Service 03	Mixer wash cycle 2 (second on the left)
Service 04	Mixer wash cycle 3 (third on the left)
Service 05	Mixer wash cycle 4 (fourth on the left)
Service 06	Coffee unit wash cycle (only on espresso models)
Service 07	Coffee grind cycle (only on espresso models)
Service 08	Coffee dose cycle (only on espresso models)
Service 09	Coffee unit forward cycle (only on espresso models)
Service 10	Nozzle movement cycle
Service 11	Normal sugar/stirrer dispenser cycle
Service 13	Stirrer dispenser cycle
Service 14	Recall powder delivery submenu: with this option, by keying in the selection from the keypad, the actual quantity of powders delivered from the doser ratiomotors can be checked. (Option only available for solubles).
Service 15	Recall recipe/water dispenser submenu: with this option, by typing the desired selection on the keyboard, you can check the actual quantity of water dispensed. (Option only available for instants).
Service 16	Emptying of air-break (see relevant paragraph). (only on espresso models)
Service 17	Emptying of pressure boiler (see relevant paragraph). (only on espresso models)
Service 18	This service displays the input status, 0 = contact closed , 1 = contact open . See diagram below:
	<ul style="list-style-type: none"> 01) CVA - Volumetric Counter 02) CCA - Water Inflow Control 03) NOT USED 04) NOT USED 05) CLR - Waste Level Control 06) CFB - Cup Present Control (photocell) 07) CDZP - Sugar/Stirrer Device Control 08) CPB - Cup Present Control 09) CMB - Cup Ratiomotor Control 10) CDB - Moving Arm Device Control 11) CRG - Unit Rotation Control 12) CPP - Pump Start Control 13) CPGC - Coffee Unit Present Control 14) CDC - Coffee Metering Unit Control
Service 19	Washing cup dispensing unit

10.2.1 ACCESS TO THE SUBMENU

Command 02 Calls submenu for setting the clock & daily timers:

Key in 02 and press the ENTER pushbutton to enter the submenu for setting the clock and daily timers. Alarm 00 will appear on the display. Follow the method described in the specific section to display and alter the parameters.

Command 03 Recall of price setting submenu (you see also Command 69):

Enter 03 and press **ENTER** to recall the submenu for price setting of each selection, and 'Selection number 0' appears on the display.

Enter the number of the selection for which you wish to display or edit the price and press **ENTER**. The text 'Price.....' appears on the display, then enter the new price value and press **ENTER** once again to memorise it, or press the **ESC** key to return to the main menu without saving the changes.

To set the price of selection 6 at € 1.20 proceed as follows:

- Programming mode, Command 0 appears on the display.
- Type 03 and press ENTER, Selection number 0 appears on the display
- Type 6 and press ENTER, the current price of Price No. appears on the display.
- Set the value 120 and press ENTER.

	<p>Programming the value of the full prices changes the value of the corresponding discounted prices by making them the same. Consequently, when selling with different prices, that is with a discount, firstly program the full price then the discounted prices and never vice versa or only one of the two.</p>
---	---

N.B.: With SPIRALI SLAVE connection enabled (see command 49), once the settings for the MASTER machine have been completed, access is gained to the setting mode for the same parameters relevant to the SLAVE machine by simply pressing the A (ESC) button. Optional NOT available on the "R" (reinforced) version.

Command 04 Calls submenu for setting discounted prices:

This command has the same functions as command 03, but it shows the discounted prices.

In the MDB mode, these prices refer to key or credit card purchases or purchases made within a certain time band, or both (see description Command 61). Furthermore, if the MDB cashless system allows the product to be selected from two different price tables, this command is used to set the prices relative to table 2. The prices relative to table 1 are set at Command 03.

N.B.: With SPIRALI SLAVE connection enabled (see command 49), once the settings for the MASTER machine have been completed, access is gained to the setting mode for the same parameters relevant to the SLAVE machine by simply pressing the A (ESC) button. Optional NOT available on the "R" (reinforced) version.

Command 05 Recall the price reference setting submenu:

This command is used exclusively to set the prices in the coin mechanism.

Type 05 and press ENTER to access the price reference setting menu and 'Selection Number 0' appears on the display. This submenu makes it possible to allocate a price number to each selection. Type the selection identification code and press ENTER; the **number** of the price allocated to the chosen selection appears, type the **number** of the new price to be allocated to the selection and press ENTER to memorise it or press ESC to return to the submenu without saving the changes. Repeat the procedure for another selection or return to the main menu by pressing the ESC key.

If, for example, you want to allocate price number 8 to selection 6 simply carry out the following procedure :

- Programming mode, Command 0 appears on the display
- Type 05 and press ENTER, Select. number 0 appears on the display
- Type 6 and press ENTER, the current price num. parameter appears on the display
- Type 8 and press ENTER.

N.B.: With SPIRALI SLAVE connection enabled (see command 49), once the settings for the MASTER machine have been completed, access is gained to the setting mode for the same parameters relevant to the SLAVE machine by simply pressing the A (ESC) button. Optional NOT available on the "R" (reinforced) version.

Command 06 Setting the product code:

This command makes it possible to allocate a 4-digit product code to each selection. This code will then be sent to the RS232 output together with the sales statistics.

N.B.: With SPIRALI SLAVE connection enabled (see command 49), once the settings for the MASTER machine have been completed, access is gained to the setting mode for the same parameters relevant to the SLAVE machine by simply pressing the A (ESC) button. Optional NOT available on the "R" (reinforced) version.

Command 07 Display of sales for full price selection:

Use this command to access the submenu which displays the number of sales for each selection; 'Selection number 0' appears on the screen. Type the identification code for the selection for which you are interested in viewing the sales data.

Press the ENTER key and the desired value appears on the display. Press the ESC key to return to the submenu which displays the number of sales for each selection by repeating the above procedure or return to the main menu by pressing the ESC key a second time.

N.B.: With SPIRALI SLAVE connection enabled (see command 49), after the MASTER machine display, access is gained to the display of the same data relevant to the SLAVE machine by simply pressing the A (ESC) button. Optional NOT available on the "R" (reinforced) version.

Command 08 Displays sales for selection discounted price:

Use this command to enter the submenu to display the number of sales per selection with full price. The display shows 'Selection number 00'. Key in the code identifying the selection of which you want to know the data of sales and press ENTER to display the requested value. Press the pushbutton ESC to return to the submenu from which it is possible to display the number of sales regarding another selection by repeating the above said procedure. Press pushbutton ENTER a second time to return to the main menu.

N.B.: With SPIRALI SLAVE connection enabled (see command 49), after the MASTER machine display, access is gained to the display of the same data relevant to the SLAVE machine by simply pressing the A (ESC) button. Optional NOT available on the "R" (reinforced) version.

Command 09 Displays totals cashed not clearable:

Use this command to display the totals regarding the transactions carried out from the initialization of the machine. The available data are the following:

Total sold, tot. in counter, tot. in tubes, tot. banknotes, tot. given back, tot. given out manually by the tubes, tot. cashed overprice, tot. discounted sales, tot. sales with system cash less, tot. sold with exact amount, tot. cashed without sales, number of sales carried out, total value of the free vends, total number of the free vends.

Command 10 Displays totals clearable:

This command has the same functions as command 09, but it can be cleared through command 92.

10.2.2 SETTING THE TEMPERATURE PARAMETERS**Command 40 Select refrigeration unit type on SLAVE:**

The command, which is only accessible when a slave machine is enabled (see Command 49), allows you to set the model of the connected slave machine.

If FAST FULLVIEW = 0

If FASTER FULLVIEW = 1

If the value is set at = 0 (FAST FULLVIEW), the values of Command 41 (internal temperature setting) are the following: predefined +8°C, and can vary between +6 + +25°C. Commands 45, 46 and 48 are also disabled.

Whereas if the value is set at = 1 (FASTER FULLVIEW), the values of Command 41 (internal temperature setting) are the following: predefined +3°C, and can vary between +2 + +25°C.

Optional NOT available on the "R" (reinforced) version.



The command setting MUST BE consistent with the machine model otherwise the machine will not function correctly.

Command 41 Set the temperature:

Espresso Vending Machine: This command allows you to adjust the working temperature of the boiler. The predefined value is 95°C, but it may vary from 65°C to 120°C.

The machine requires the temperature differential, a value which is added to the boiler's working temperature to compensate the heat loss of the selected beverage caused by the dispersiveness of the dispensing system after a period of inactivity. This value is predefined at +15°C.

N.B.: The sum of the above values must not exceed 120 °C.

If the slave machine is enabled, the user is requested to set the internal temperature of the snack machine, that is, the temperature below which the compressor switches. Depending on the type of SLAVE connected to the machine, the possible values to be entered are defined in Command 40.

Instant Vending Machines: This command allows you to adjust the working temperature of the boiler. The predefined value is 88°C, but it may vary from 60°C to 99°C.

If the slave machine is enabled, the user is requested to set the internal temperature of the snack machine, that is, the temperature below which the compressor switches. Depending on the type of SLAVE connected to the machine, the possible values to be entered are defined in Command 40.

Command 43 Set the temperature at the end of defrosting : (only slave machine)

This command is used to set the temperature of the evaporator beyond which, after dripping, the compressor can resume operation; this is to guarantee that the evaporator is completely defrosted. The command is preset at 3°C and may vary between 3°C and 12°C.

Optional NOT available on the "R" (reinforced) version.

Command 44 Set the defrosting frequency: (only slave machine)

This command sets the defrosting frequency expressed in hours, that is, the time between one defrosting cycle and the next. The preset value is for 4h but can vary between 1h and 8h.

Optional NOT available on the "R" (reinforced) version.

Command 45 Setting the cut-out duration for the refrigeration safety device:

(only on FASTER FULLVIEW)

This command sets the amount of time that the refrigeration safety device is to remain disabled. This period of time prevents the vending machine from shutting down following an operation that involves having the door open with the subsequent increase in the internal temperature. The delay in activating the refrigeration unit safety device gives the machine time to return to its normal operating temperature. The value of this command is preset at 60 min. but can be varied from 30 to 360 min.

Optional NOT available on the "R" (reinforced) version.

Command 46 Setting the trigger temperature for the refrigeration safety device:

(only on FASTER FULLVIEW)

This command sets the trigger temperature for the safety device, that is the temperature above which it prevents the machine from vending the selected product (see Command 48). A warning message appears on the display when the user attempts to make one of these selections. This control is disabled when the machine is switched on and after the door is shut for a period of time set on command 45. The preset value is +7°C but it can be changed to between +7°C and +35°C. When the safety device is triggered, the relevant selections remain out of service until the next time the door is opened/closed.

Optional NOT available on the "R" (reinforced) version.

Command 48 Setting trays with refrigeration safety device:

(only on FASTER FULLVIEW)

This command allows you to select which trays are subject to the refrigeration safety device. The command requires a setting for each tray: enable safety device = 1, or disable safety device = 0. Tray 1 refers to the top tray. By default, all the trays are set at 1.

Optional NOT available on the "R" (reinforced) version.

10.2.3 TO SET MACHINE PARAMETERS

Command 49 Enabling/Disabling spirali slave:

This command enables the master/slave connection. It is possible to connect up to two slave snack machines. **Command 40** must be set after the connected slave machines have been enabled.

Optional NOT available on the "R" (reinforced) version.

	See the specific manual for how to set the slave machine .
---	--

Command 50 Set the machine model:

Enter code 1221 to access the machine model setting, select a particular model from the **MACHINE CONFIGURATION TABLES** (see relevant paragraph).

To finish, the user is asked to enter a numeric code with max. 8 digits, which is used as the identification code when the programming of the parameters is carried out using the key system.

	The command setting MUST BE consistent with the machine model otherwise the machine will not function correctly.
---	---

Command 51 Set the recipe doses:

This command is used for changing the doses of the recipe for a selection. After confirming, by pressing the "B" button, the values of the doses of the selection components including the "extra-mixer" times (mixer operating time after dispensing, to draw in the residual vapours; programmable value min 0, max 90 = 9 sec.), the command displays the "mixer" parameter, that is the quantity of cold water arriving directly from the airbreak. The available values range from 0 (no mixing) to 9 (max mixing). Finally, dispensing of the stirrer is requested. Value 1=stirrer YES, value 0=stirrer NO.

Then, it will be possible to carry out the powder dispensing test for the selection which was just modified (see also SERVICE 14).

N.B.: The water dose is always associated to each type of instant or coffee product which makes up the recipe . The espresso coffee dose is calibrated mechanically by the coffee metering unit .

Command 52 Recall services submenu:

Type 52 and press ENTER to recall the services setting submenu; '**Service 00**' appears on the display. It is possible to carry out all the functions listed in the SERVICES LIST paragraph.

If any alarms have been tripped, before accessing the various 'Services' available, press button "B" (ENTER) to scroll the list of alarms, at the end of which the following message appears: "CLEAR DATA?". Press "B" (ENTER) to eliminate all the alarm conditions, or press "A" (ESC).

Command 53 Sugar dose setting:

Espresso vending machines: this command is used for setting the quantity of normal sugar, common to all the selections, expressed in tenths of a second. By default the normal sugar dose is 13 tenths equal to approx 6.5 g. When making a selection the user can use the + and – buttons located on the front panel to vary the quantity of dispensed sugar with respect to the average dose. Next the system requires you to match the dose defined in the sugar preselection to the number of indicator lights appearing on the display. Default value 2 (indicator lights) and can vary from 1 to 5.

Command 54 Presence of optional kits:

Parameter one: defines the presence or not of the autonomous kit. If set at 1 it indicates that there is a canister of water and associated pump, if it is not possible to connect the distributor to the water mains. Default value 0.

Parameter two: defines whether or not the cup photocell is present. If present = 1, not present = 0; Default value = 0

Parameter three: if parameter two is set at zero, the function makes it possible to enable =1, the "NO CUP" button; the button used to exclude the cup is the one normally used for the more sugar pre-selection. The button normally used for the less sugar preselection, will have the more/less sugar preselection function.



Parameter four: if the machine does not envisage the use of a spoon dispenser as default (e.g. instant models), the spoon dispenser option is proposed. Value to set at 1 only if a spoon dispenser is installed later.

Parameter five (espresso models): setting the espresso unit prewash time, from 0 minutes (prewash disabled), to 30 minutes. The default value is 30 min.

Parameter six (espresso models): defines the quantity of water required for the espresso unit prewash. The default value is set at 5 cc and can vary from 5 to 50 cc. If 0 = the parameter is disabled.

Parameter seven: enables the prewashing of the mixer that receives the milk. If 1 = enabled , if 0 = disabled.

Parameter eight (espresso models): prewash with coffee powder = 1 or with water only = 0. Once the time set in parameter four has elapsed, the machine, if a selection with espresso coffee is requested, carries out the espresso unit wash first in order to heat the circuit. The time starts up again from zero every time the espresso unit is activated by one of the selections. At power up, the first espresso coffee is always preceded by a prewash if this is enabled. The prewash modes, if enabled, are applied with the following criteria:

- a) If the beverage consists only of espresso coffee, the prewash is carried out if it is less than approx. 40 CC.
- b) If the beverage consists of espresso coffee plus a powder the prewash is carried out if it is less than approx 60 CC.

Command 55 Setting the espresso coffee instant grinding:

If the command is set at 1, the default value, the coffee is ground for the delivery in progress, whereas, if it is set at 0, the coffee is ground for the next delivery.

Command 56 Activation of the prompt change function:

If the command is set at 1, before executing the selection the vending machine collects the credit. If it is set at zero, which is the default value, the credit is collected once the selection has been dispensed. This function is useful in the master/slave connection as the slave machine becomes ready immediately for a new selection. Whereas the credit which is deducted immediately after the selection on the "Master" machine, is not returned to the customer in the event of an uncompleted sale.

Command 57 Setting cup column stopping delay and dispenser spouts retracting delay:

The command regulates the delay for the stopping action of the cup column, which ensures an accurate alignment between the tube and the cup outlet opening. The delay is counted from the moment the cup presence microswitch switches over. Default value: 12 tenths of a second, but it can vary between 5 and 30. Next adjust the delay for the retracting spouts after the dispensing action. Default value : 50 tenths of a sec, but it can vary between 20 and 70.

Command 59 Stroke counter :

If the command is set at 1, the stroke counter appears every time the machine is switched on.

Command 60 Erases the memory:

	When this command is activated all the previous data set by the user are cancelled.
---	--

Enter the figure 6203 then press the ENTER key to cancel all the data stored in the vending machine's memory. The procedure to cancel the data from the memory is as follows:

- Programming mode, Command 0 appears on the display
- Type 60 and press ENTER, Code 0000 appears on the display
- Type 6203 and press ENTER, 'memory cleared' appears on the display

Note: To exit from the command press the button on the VMC board once.

The machine then asks the user to enter the parameters relevant to command 50.

Command 61 Reset security/access code:

This command makes it possible to reset the access code used in the EVA_DTS protocol.

Command 62 Enable discount:

The following discount types can be enabled depending on the value set in this parameter:

0 = no type of discount.

1 = discount for different time slots.

2 = discount for purchases with key /credit card (only possible in MDB mode).

3 = discount for time slots and for purchases with key /credit card (only possible in MDB mode).

N.B. Enter the values of the desired time slots in daily timer 2 in order to enable the application of the discount.

For machines with the cashless system this command makes it possible to apply different price tables. The selection of the table to be applied at the time of sale occurs automatically through the communication protocol between machine and reader (only possible for MDB cashless systems which are provided with this option).

Command 63 Set the mono/multivend:

If the command is set at 0, the default value, the vending machine operates in monovend mode, and in cash mode the surplus credit is returned. If this is not possible the sum is added to the amount totalled due to overpricing. Vice versa, if the command is set at 1, the vending machine operates in multivend mode, and the amount which exceeds the cost, after the sale, is displayed once again and can be recovered by simply pressing the coin return button or used for a new selection.

Command 64 Sets the message display language:

This command controls the language in which the messages are displayed. Value 0 corresponds to Italian, value 1 to English, value 2 to French, value 3 to German, value 4 to Dutch, value 5 to Swedish, value 6 to Finnish and value 7 to Spanish 8 to Portuguese 9 to Danish 10 to Norwegian.

Command 67 Display of spiral slaves temperature :

When this command is set at 1, the internal temperatures of any slave machine which may be connected to this one appear on the display.

Optional NOT available on the "R" (reinforced) version.

Command 68 Setting displayed currency description :

The command allows the operator to set the desired currency. 4 characters are available and they are entered using the same method as described for **Command 95**.

Command 69 Chooses functioning mode of the coin mechanism:

This command chooses the type and mode of functioning of the coin mechanism. The parameter can assume the following values:

- 0 System EXECUTIVE with prices controlled in the machine (see relevant paragraph).
- 1 System EXECUTIVE in PRICE HOLDING mode (i.e. prices programmed in the coin mechanism). In this case, the prices programmed at command 03 and those programmed in the coin mechanism must be the same (see relevant paragraph). Alternatively you can set the "Price-Display" parameter. If enabled, the vending machine will utilize exclusively the information on the price value deriving from the payment system, that is, it will not be necessary to fill in the price tables (Commands 03 and 04); simply set only Command 05 (see relevant paragraph).
- 4 System BDV 001 (see paragraph using the coin mechanism BDV)
- 5 Payment system MDB (see paragraph on using the MDB payment system).



Every time this value is altered, the vending machine must be turned off for a few seconds. By switching it on again the machine and the coin mechanism will communicate correctly.

Command 70 Buzzer operation option:

By setting this command at zero the buzzer is disconnected during machine operation.

Command 80 Cloning:

This command makes it possible to transfer all the parameters of the vending machine to a "Program Key", to program same model machines (see also **Command 50**). When you enter the command "Write Clone Key" appears on the display. Then, enter the "Program Key" and press the ENTER key. "Data Writing...*" appears on the screen while the data is being transferred to the key. Once the data transfer operation is completed, the machine returns to the programming mode.

Caution: DO NOT enter the key before entering the programming mode, otherwise the vending machine will fetch the data existing in the key.

Command 81 Fetch vend data:

This command makes it possible to transfer all the EVA-DTS data to a "Program Key". This data can be extracted using special software (VMC configurator). The maximum number of possible registrations is 100. Attention: if the key is not recognised as a data key, at the first registration the user will be asked to confirm the complete deletion of the existing data.

Command 85 Display of checksum and main and power board software version.

Command 90 Select AUDIT protocol:

The control card has a jack RS232.

The connector I/O is a 9 poles with male container in which the following pins are used:

- Pin 2 Tx - Pin 7 DTR - Pin 5 Ground

The transmission happens according to the following specifications:

- 9600 baud - 8 bit of data - no parity

The transfer of the data is ruled by a control signal DTR (active high) given by the device to fetch data.

The data fetch from the machine happens as follows:

Connection of the device to fetch data to the jack RS232.

Press pushbutton data sending.

After the transmission of data the request to disconnect the device is displayed.

Through command 90 it is possible to choose the quantity of data sent to the jack RS232. There are three levels:

- level 1 totals regarding the transactions
- level 2 totals regarding the transactions of level 1, plus sales per each selection
- level 3 totals regarding the transactions of level 1, data regarding the last 5 power off and on of the machine; data regarding the error events that have happened.

If the command is set at 4, the machine dialogue with the outside world is achieved by means of an 082928 infrared interface, based on the specifications of the EVA-DTS protocol.

If the command is set at 5 the machine dialogues with the external world through an infrared 082925 interface (IRDA interface), according to the specifications of the protocol EVA-DTS vers.5.0.

Then, if the preceding option has been set at 4 or 5, the machine proposes selecting the input / output direction: towards the infrared interface (082928 or 082925 OPTICAL LINK) or towards RS232 (connector situated on the card). In the latter case the connector pins used are 2= VMC Tx, 3=VMC Rx, 5= GROUND in which case the transmission speed is fixed at 9600 baud. To select press any key on the keyboard to scroll the various direction options and confirm the desired value by pressing "B"

If the initial option is set at 5 the machine requests that the peripheral address be inserted: key in the desired value and press "B".

If the initial option is set at 5 the machine offers the choice of the drive speed that must be consistent with the setting on card no. 082925 (see relevant instructions). The settable range is between 2400 baud and 19200 baud, or negotiable between machine and terminal (option only valid for connection with cable). To select press any key on the keyboard to scroll the various speed options and confirm the desired value by pressing "B".

If the command is set at 6 the machine dialogues with the user by means of DEX-UCS protocol.

Command 91 Enter machine identification data:

The first datum requested in alphanumeric format with max 30 characters refers to the machine location; see the table in command 95 for details on how to enter the description. The second datum requested is the numeric machine identification code (asset number).

Command 92 Clear sales data:

The command is used to clear the machine's sales data (see command 10). A special access code must be entered for this operation. The procedure is as follows:

- Programming mode, Command 0 appears on the display
 - Type 92 and press ENTER, Code 0000 appears on the display
 - Type 1221 and press ENTER, 'CLEAR DATA?' appears on the display
- Press the ENTER key to clear all the sales data whereas press ESC to return to the main menus without saving the changes.

Command 93 Displays the temperature status over the last 24 hours:

Option available for the slave machines if enabled and if the FASTER type (see Command 49).

This command displays the trend of the internal temperature during the last 24 hours. The values are recorded every 60 minutes. To view all the values simply press the 'B' button.

The values can only be recorded if the clock is programmed (see Command 02).

After programming the clock, all the data is automatically zeroed.

Optional NOT available on the "R" (reinforced) version.

Command 94 Displays the last 10 power-offs:

This command displays the last 10 periods in which the machine has been put off.

The following values are displayed:

POWER OFF DATE TIME

POWER ON DATE TIME

To pass to another display press pushbutton ENTER.

N.B.: The clock has to be programmed to obtain reliable values.

Command 95 Enter user message 1 (max 63 characters):

This command makes it possible to enable and enter the first of the two messages which can be edited by the manager. This message is displayed in STAND-BY when the payment system can deliver the change.

Type 95 and press the ENTER key, the user is asked to enable or disable the user message (value 1=enabled, value 0=disabled).

If it is enabled, the message which is currently available appears on the first line of the display whereas the text **"Character 00"** appears on the second line of the display. To compose the new message type in the required character codes (see table below) and confirm each one by pressing the ENTER key. Lastly, press the ESC key to return to the main menu.

CODE	CHARACTER	CODE	CHARACTER	CODE	CHARACTER
00	Cursor ahead	28	E	56	g
01	Cursor back	29	F	57	h
02	space	30	G	58	i
03	!	31	H	59	j
04	"	32	I	60	k
05	#	33	J	61	l
06	\$	34	K	62	m
07	'	35	L	63	n
08	,	36	M	64	o
09	-	37	N	65	p
10	.	38	O	66	q
11	/	39	P	67	r
12	0	40	Q	68	s
13	1	41	R	69	t
14	2	42	S	70	u
15	3	43	T	71	v
16	4	44	U	72	w
17	5	45	V	73	x
18	6	46	W	74	y
19	7	47	X	75	z
20	8	48	Y	76	á
21	9	49	Z	77	â
22	:	50	a	78	ü
23	;	51	b	79	£
24	A	52	c	80	ä
25	B	53	d	81	ñ
26	C	54	e	82	ö
27	D	55	f		

The character with the 00 code moves the cursor forward by one position.

CAUTION! : If the cursor is on the other side of the first character of the message and you press the ESC key to return to the main menu, the message is cut off at the point which corresponds to the position of the cursor; therefore before quitting, make sure that the cursor is moved to the end of the message.

It is advisable to prepare the message on a piece of paper using the codes in the table (spaces included) and then enter it in the machine.

Command 96 Enter user message 2 (max 63 characters):

This command makes it possible to enable and enter the second of the two messages which can be edited by the manager. This message is displayed in STAND-BY when the payment system can not deliver the change. To enter this message the same rules apply as those for the preceding command.

Command 99 View error events:

This command displays the last 20 error events; to go from one display to another press the B key. At the end of the display, the system asks the user to confirm the clearing of all the data. Press ENTER to confirm or ESC to leave the records as they are.

ERROR CODE	SUB-CODE	FAILURE
102	/	Waste Level
103	/	Low Water Level
104	/	Cup Holder Empty
105	/	Dispensing Arm Error
106	/	Sugar-stirrer dispenser
107	1 / 2	Coffee unit jammed in open pos. (CRG micro does not close)
108	/	Coffee metering unit doser
109	1 / 2	Coffee unit does not reach closed pos.(CPP micro does not close)
110	/	Coffee dispensing timeout (volumetric meter)
111	1 / 2	Coffee unit does not reach open pos. (CRG micro does not open)
112	/	Grinding timeout
113	/	Coffee unit not installed
114	/	Cup dispenser with photocell error
115	/	Faulty pressure boiler temperature probe
116	/	Faulty gravity boiler temperature probe
117	/	Instant dispensing timeout (volumetric meter)
119	/	Cup dispenser micro does not close
120	/	Wrong dose.
121	/	Coffee unit opens while dispensing (CPP opens while dispensing in progress)
122	1 / 2	Coffee unit jammed in closed pos. (CPP does not open)
123	/	Cup dispenser micro does not switch over
130	/	Payment system out of service.
132	/	Interrupted communication between main board and power board
10 (**)	(*) 39 - 40	Internal temperature feeler faulty
11 (**)	(*) 39 - 40	Evaporator probe faulty
16 (**)	(*) 33 - 36 - 39 - 40	Error communication with peripheral (a board for the electric panel)
17 (**)	(*) 39 - 40	Communication break during sale cycle without credit collection
18 (**)	(*) 39 - 40	Communication break during sale cycle with credit collection
31 (**)	(*) 39 - 40	Photocell test error .
32 (**)	(*) 39 - 40	Photocell calibration error
51 (**)	(*) 39 - 40	Interruption of peripheral connection at the beginning of the sale cycle.
55	/	Payment system out of service.
61 (**)	Number selection code	Motor blocked (the spiral does not rotate) SLAVE A
62 (**)	Number selection code	The spiral does not complete the rotation SLAVE A
65 (**)	Number selection code	Motor disconnected SLAVE A
69 (**)	Number selection code	Possible microswitch defect or spiral motor wiring defect SLAVE A
71 (**)	Number selection code	Motor blocked (the spiral does not rotate) SLAVE B
72 (**)	Number selection code	The spiral does not complete the rotation SLAVE B
75 (**)	Number selection code	Motor disconnected SLAVE B
79 (**)	Number selection code	Possible microswitch defect or spiral motor wiring defect SLAVE B

(*)Key:

33 = Photocells
 36 = Powerboard Fashion
 39 = Spirali Slave A
 40 = Spirali Slave B

(**) Optional NOT available on the "R" (reinforced) version.

10.2.4 TO SET MACHINE SLAVE PARAMETERS

Optional NOT available on the "R" (reinforced) version.

Command 73 Enabling the photoelectric cells FAST FULLVIEW:

This command should be set at 1 only if the photoelectric cell system is installed. Its function is to enable=1/disable=0 this device.

Set the command at 1 (photocells enabled), to automatically access the menu which allows this function to be disabled if necessary for the desired selections (delivery without photocell control). To disable the option corresponding to one or more selections, simply key in the selection number and then set the value at zero.

Command 74 Photocell test FAST FULLVIEW:

This command is used to test that the photocells are functioning correctly. A test procedure is started automatically, then at the end of the procedure, if there are no problems a single value appears which corresponds to the magnitude of the incoming signal. If there is a problem with the functioning, a second value appears on the display which refers to the problem. See the table for Command 99 for this second value.

Command 75 Setting the operating parameters of the photocell barrier FAST FULLVIEW:

This command allows the operator to view and change the operating parameter of the photocell barrier.

Message	Default value	Meaning
"Hyster.HL"	6	This parameter acts on the sensitivity of the reading of the system. The lower the value set in this parameter, the greater the sensitivity of the system. The value can vary from a minimum of 5 to a maximum of 30.

Command 76 System's operating options ("FTC Options ") FAST FULLVIEW:

Setting this command determines how the machine will react if the product is not delivered. The value can be set at between 0 and 3. Default = 0.

The meaning of the setting is as follows:

0 = Possibility of another selection; in this case command 63 (single-multisale) must be set at 1 (if it is an executive payment system the multisale must also be set in the payment system).

1 = Automatic credit delivery; in this case command 63 must be set at 0 (if it is an executive payment system the single sale must also be set in the payment system).

2 = Further quarter turn: if the product is not delivered the spiral completes a further 1/4 turn and if the product has still not been delivered then the machine reverts to one of the preceding two options depending on the single or multisale parameter that has been set.

- *For this purpose once the value 2 has been set in command 76, the option is disabled for all the selections by default. Then you automatically access the menu that allows you to enable the option for the individual spirals. To enable the option corresponding to a spiral simply enter the selection number and set the value at 1. Vice versa if this value is set at 0 the option is disabled. The option is not applicable to ½ turn spirals. If the payment system uses Executive protocol, the single-multivend must also be set on the payment system.*
- *Alternatively, the function can be enabled / disabled for each drawer: selection 91 implies that all the selections in the first drawer from the top are, for example, enabled for the quarter turn function. Selection 92 = 2nd drawer; 93 = 3rd drawer; 94 = 4th drawer; 95 = 5th drawer; 96 = 6th drawer; 97 = 7th drawer; if you program the function for selection 99, all the selections in the vending machine will be enabled or disabled.*

The system then asks you to enter the options relevant to the PHOTOCCELL SAFETY:

enabling this function (parameter setting = 1) involves entering a number of products within a certain time frame (in minutes). If within the programmed time interval a number of non-readings occurs that is equal to the number of programmed products, the photocells are disabled. The active event is signalled on the display when the door is opened and it is also recorded in Command 99 by Error code 39. The photocell reset can be programmed in manual or automatic mode. If manual, parameter setting = 0, enter the TEST VEND function to re-enable the photocells; if automatic, parameter setting = 1, after 15 minutes the system attempts to reset the function.

*N.B.: with the SPIRAL SLAVE connection enabled (see **Command 49**), after setting the MASTER machine, the same parameters for the SLAVE machine can be set.*

10.2.5 SETTING THE CLOCK AND DAILY TIMERS

Alarm set 01 Sets the year/month/day:

This command is used to set the year, month and day on the clock in the control board. The introduction format is YYMMDD.

Alarm set 02 Sets the hour and minute:

This command is used to set the clock on the control board. Enter the correct hour and minute values and press ENTER to memorise it. Then, enter 1 to have the clock appear on the display, otherwise enter 0.

Alarm 10 Lighting control setting:

Use this control to set the lighting all off = 0 or, dimming of the lighting = 1 during the energy saving time slots (see Alarm 11).

Alarms 11–14 Lights on/off:

With these commands two daily periods can be programmed for switching the lighting on and off. However, even in the periods when the lighting is programmed off, simply pressing a button on the keyboard or inserting money will activate the lighting for a period of 3' for the vend cycle to take place. To disable this time command simply program value 24 in command 11.

If, for example, you wish to activate the lighting from 11 to 12 and from 13 to 14, proceed as follows:

1. Programming mode, the following appears on the displayCommand 00
2. Type 02 and press ENTER, the following appears on the display Alarms 00
3. Type 11 and press ENTER, the first lights ON time appears on the display NNNN
4. Set value 1100 and press ENTER.
5. Type 12 and press ENTER, the first lights OFF time appears on the display..... NNNN
6. Set value 1200 and press ENTER.
7. Type 13 and press ENTER, the second lights ON time appears on the display NNNN
8. Set value 1300 and press ENTER.
9. Type 14 and press ENTER, the second lights OFF time appears on the display..... NNNN
10. Set value 1400 and press ENTER.

N.B.: The periods must be programmed in the sequence 11-12-13-14.

If this function is not required, program 2400 in **Alarm 11**.

Alarms 21–24 Setting the discount time slots :

These commands are used to set the discount sales time slots throughout the day. In the time slots when the discounts are activated the machine refers to the prices set in the discount prices submenu. Naturally, command 62 in the main menu must be set at 1.

For example, to set a discount period lasting from 10.30 to 13.30, proceed as follows:

1. Go into programming mode to display_Command 00_
2. Key in 02 and press button ENTER to display_Alarm set 00_
3. Key in 21 and press button ENTER to display the time when discounted prices are first activated. _NNNN_
4. Set value to 1030 and press button ENTER.
5. Key in 22 and press button ENTER to display the time when discounted prices are first deactivated _NNNN_
6. Set value to 1330 and press button ENTER,

N.B.: The periods must be programmed in the following order: 21-22-23-24.

If use of this function is not required, programme 2400 at **Alarm 21**.

Alarms set 31-34 Selections disabled for daily time periods:

These commands allow the selections set at command "Alarm 36" to be disabled for two time periods per day.

Alarm set 31 = selection disabled period start

Alarm set 32 = selection disabled period end

Alarm set 33 = second selection disabled period start

Alarm set 34 = second selection disabled period end

N.B.: The periods must be programmed in the following order: 31-32-33-34.

If use of this function is not required, programme 2400 at **Alarm 31**.

Alarm 36 Setting the selections with timed disabling :

Upon entry to the command the system asks the operator to disable the option that concerns the entire machine including any slave machines that may be connected (option 1), or not (option 0). If option 0 is selected, the command allows the operator to choose which selections must be disabled during the time slots when the "selections disabled" function is enabled (see programming **Alarms 31-34**).

Example:

To activate the disabled time slot for selection 15 proceed as follows:

1. Programming mode, Command 00 appears on the display
2. Type 02 and press B, Alarms 00 appears on the display
3. Type 36 and press B, , Select. number 00 appears on the display
4. Type 15 and press B, , Dis./En.1/0 N appears on the display
5. Set the value 1 and press B.

N.B.: With SPIRALI SLAVE connection enabled (see command 49), once the settings for the MASTER machine have been completed, access is gained to the setting mode for the same parameters relevant to the SLAVE machine by simply pressing the A (ESC) button. Optional NOT available on the "R" (reinforced) version.

Alarm 41 Sequential washing times setting:

This command allows you to select the times for the instants wash function to operate every day.

If this function is not required, program 2400 in **Alarm 41**.

10.3 USING THE EXECUTIVE STD/EXECUTIVE PRICE HOLDING PAYMENT SYSTEMS



The decimal point in the prices that appear on the display must be set through the payment system.

Executive Standard ⇒ Command 69 programmed at 0

The Executive standard payment system manages the prices directly in the machine and not on the payment system.

For example, to set selection 21 at 30 pence, follow the instructions below:

- | | |
|--|-------------------------|
| 1.1) Enter programming mode to display | Command 00 |
| 1.2) Key in 03 and press B to display..... | Selection No. 00 |
| 1.3) Key in 21 and press B to display..... | Price 00 |
| 1.4) Key in 30 and press B to display..... | Selection No. 00 |

If you wish to programme another selection, repeat the sequence from point 1.2. Alternatively, press A twice.

Executive price-holding ⇒ Command 69 programmed at 1

In the Executive price-holding, the prices are managed by the payment system.

In this case, it is necessary to copy the price table (price list) programmed on the payment system to command 03 of the machine (from price 1 to price n) , while at Command 05 the prices will be matched to the selection by referring to their number.

For example, to set the selection 11 at 35 pence, proceed as described below:

Let us assume that the second price set on the payment system is 35 pence.

- | | |
|--|------------------------|
| 1.1) Enter programming mode to display | Command 00 |
| 1.2) Key in 03 and press B to display..... | Price Number 00 |
| 1.3) Key in 02 (second price) and press B to display | Price 00 |
| 1.4) Key in 35 and press B to display..... | Price Number 00 |
| 1.5) Press A to display | Command 00 |
| 1.6) Key in 05 and press B to display..... | Selection No 00 |
| 1.7) Key in 11 and press B to display..... | Price Number 00 |
| 1.8) Key in 02 (second price) and press B to display | Selection No 00 |

If you wish to programme another selection, repeat the sequence from point 1.6. Alternatively press A twice.

Executive price-display ⇒ Command 69 programmed on 1.

In the Executive price-display payment system the prices are controlled by the payment system.

In Command 05 the prices referring to the number of the selection will be matched to the selection.

Example:

- | | |
|--|-------------------------|
| 1.1) Type 05 and press ENTER, the screen displays | Selection No. 00 |
| 1.2) Type the selection no. and press ENTER, the screen displays..... | Price Number 00 |
| 1.3) Type for example 02 (second price) and press ENTER, the screen displays | Selection No. 00 |

If you wish to program another selection repeat the sequence from point 1.1 otherwise press ESC twice.

10.4 USE OF COINMECHANISM BDV 001



The coin mechanism must only be connected/disconnected with the machine switched off.

After having carried out the connection, switch on the machine, enter the programming and set **command 69 to 4**, then switch off the machine for some seconds. By switching it on again the machine and the coin mechanism will communicate correctly.

Command 30	Purchase obligation before return	(def. 0)
Command 31	Maximum credit	(def. 0)
Command 32	Maximum value of returned coins	(def. 0)
Command 33	Inhibition single coins	(all enabled)
Command 34	Coin inhibition with exact amount	(all enabled)
Command 35	Coin level message exact amount	(def. 0)
Command 36	Equation exact amount	(def. 0)
Command 37	Enabling credit card reader	(def. 0)
Command 38	Emptying of change giving tubes	
Command 39	Filling up of change giving tubes	

Command 30 Purchase obligation before return:

By setting this command to 1 the customer is obliged to purchase before receiving back the return. This is to avoid to use the coin mechanism as a coin-changer. If the purchase fails to happen, the return will be given out.

Command 31 Maximum credit:

The maximum credit accepted by the coin mechanism is set. By overtaking this value the acceptance of further coins is blocked.

Command 32 Maximum value of returned coins:

This function is active only in multi-sale. If the value of the credit which remains after a sale is higher than the value set by the command, the allotment of return will be blocked. Therefore it will be necessary to carry out further purchases until the remaining credit will be lower than the set value. By moving the return lever it will be possible to obtain the return.

Command 33 Inhibition single coins:

The acceptance of particular coins by the coin mechanism will be blocked through this command. If you want to block the acceptance of coin 5, proceed as follows:

1. Programming mode, display views Command 00
2. Dial 33 and press B, display views Coin no. 00
3. Dial 5 and press B, display views 0
4. Dial 1 and press B.

Command 34 Coin inhibition with exact amount:

This command blocks the acceptance of particular coins in case of small return, i.e. when the display views the message "Insert only exact amount".

Command 35 Coin level message exact amount:

A value between 0 and 15 representing the number of coins to be added to the minimum level fixed in the coin return tubes - can be programmed, in order to quit the "exact amount" condition.

Command 36 Equation exact amount:

It represents the combination of empty spaces in the tubes so that the message exact amount can be activated. Here is a list of possible combinations:

0 = A or (B e C)	1 = A and B and C	2 = only A and B
3 = A and (B o C)	4 = only A	5 = only A or B
6 = A or B or C	7 = only A and C	8 = only A or C
9 = only B e C	10 = only B	11 = only B or C
12 = only C		

Command 37 Enabling credit card reader:

The functioning of the credit card will be enabled by setting this command to 1.

Command 38 Emptying of change giving tubes:

This command is used to inventory the coins in the tubes of the coin mechanism. To obtain the allotment from tube 1 (coins of lower value) proceed as follows:

1. Programming mode, display views Command 00
2. Dial 38 and press B, display views Tube no. 00
3. Dial 1 and press B,

The coin mechanism starts giving out coins from the chosen tube until the release of pushbutton B.

Command 39 Filling up of change giving tubes:

Proceed as follows:

1. Programming mode, display views Command 00
2. Dial 39 and press B
3. Insert the coins into the coin mechanism.
4. Press again pushbutton B

N.B. If the procedure is not correctly carried out, you can find wrong values in commands 09 - 10.

10.5 USE OF PAYMENT SYSTEMS MDB



The coin mechanism must only be connected/disconnected with the machine switched off.

The command **69** has to be programmed to value **5**, then turn off the machine for some seconds. By putting it on again the machine and the coin mechanism will communicate correctly. There are the following additional commands for the use of these payment systems:

Command 27	Setting the signal for payment system out of order.
Command 28	Select change giving tube content counter.
Command 29	Cashless credit cannot be displayed.
Command 30	Purchase obligation before return.
Command 31	Setting max key or cash credit accepted.
Command 32	Minimum coin level in the tubes.
Command 33	Disabling single coins / banknotes
Command 34	Inhibits coins during exact amount.
Command 35	Resetting coin meters in change giving tubes.
Command 36	Condition exact amount (no coins available for change).
Command 37	Inhibits note validator during exact amount.
Command 38	Emptying of change giving tubes.
Command 39	Filling in of the change giving tubes.

Command 27 Setting the signal for payment system out of order:

If the command is set at 1, when the connection with the MBD payment system is interrupted the vending machine goes out of order and the message appears on the display; if the command is set at 0 (zero), the option is disabled. The default setting is 0.

Command 28 Select change giving tube content counter:

This command allows the user to select whether to use the counters corresponding to the content of the coin mechanism change giving tube or use only the counters inside the machine. If the command is set at 1 at each power-up the counters inside the machine which correspond to the content of the change giving tubes are updated with the values transmitted by the coin mechanism. If, on the other hand, the command is set at 0 the values transmitted by the coin mechanism are ignored.

Command 29 Cashless credit cannot be displayed:

This command allows the user to prevent or enable display of credit from the MDB cashless device (key or card reader). If the command is set at 1 the credit corresponding to the cashless device is not displayed, whereas if the command is set at 0 the machine also displays the credit available on the cashless device.

Command 30 Purchase obligation before return:

By setting this command to 1 the customer is obliged to purchase before receiving back the return. This is to avoid to use the coin mechanism as a coin-changer. If the purchase fails to happen, the return will be given out.

Command 31 Setting max key or cash credit accepted:

The max credit accepted by the coin mechanism by either key/card or cash is set, and if this amount is exceeded acceptance of further coins or notes is blocked.

1. Programming mode, display views Command 00
2. Key in 31 and press B, display views..... Maxkey xxxx
3. Key in amount required (key max credit) and press B.
4. Display views Maxcash xxxx
5. Key in required amount (cash max credit) and press B.

Command 32 Minimum coin level in the tubes:

This is the number of coins for each coin box mechanism which must remain in each tube in order to guarantee the correct function of the coin delivery system. (Consult the manual of the coin box mechanism for instructions on setting the correct value of this parameter). If a different value is associated to each tube, the maximum value set must be between those indicated. The setting of this parameter is fundamental for ensuring the correct coin management by the vending machine.

N.B. The inventory of the tubes, command 38, stops when the contents of each tube reaches the value set at command 32. To empty the tubes completely, use the delivery pushbuttons of the coin box mechanism.

Command 33 Disabling single coins / banknotes:

This command allows you to perform the two adjustments described below:

- 1) To block acceptance of particular coins by the coin mechanism.
- 2) To block acceptance of particular banknotes by the reader.

Pres the ESC button to go from point 1 to point 2.

N.B.: The coins are in order of increasing value.

Command 34 Inhibits Coin inhibition with exact amount:

This command blocks the acceptance of particular coins during small change giving, i.e. when the display shows the message "insert only exact amount".

1. Go into programming mode to display Command 00
2. Key in 34 and press B to display Coin No. 00
3. Key in 5 and press B to display 1
4. Key in 0 and press B.

N.B.: To activate the possible modifications of command 33, turn the machine off and then on after modification itself.

Command 35 Resetting coin meters in change giving tubes:

Use this command when replacing token meter or emptying the change giving tubes with the machine off to synchronize the meters with the actual contents of the change giving tubes.

1. Programming mode, display views Command 00
2. Key in 35 and press B , display views Code 0000
3. Key in 6203 and press B.

Command 36 Condition exact amount (no coins available for change):

This command is for setting (for each change giving tube) the number of coins below which the machine can be considered to be in a condition of 'no coins available for change'. The set value must always take into consideration the coin minimum level in the tubes (command 32), that is it must be higher than the latter (example: if command 32 is set at 5, the command 36 values must have a setting of 6 as their minimum value). The tubes that are not included in this condition must be set at "0".

When the contents of any one of the tubes included in the condition drops below the corresponding set value the machine displays the warning that there are no coins available for change.

Command 37 Inhibits note validator during exact amount:

Setting this command to 1 during exact amount will inhibit the note validator.

N.B.: If only the note validator is installed, this command has to be set to 0.

Command 38 Emptying of change giving tubes:

This command is used to inventory the coins in the tubes of the coin mechanism. To obtain the allotment from tube 1 (coins of lower value) proceed as follows:

1. Programming mode, display views Command 00
2. Dial 38 and press B, display views Tube no. 00
3. Dial 1 and press B,

The coin mechanism starts giving out coins from the chosen tube until the release of pushbutton B.

Command 39 Filling in of the change giving tubes:

Proceed as follows:

1. Go into programming mode to display Command 00
2. Key in 39 and press B
3. Insert the coins in the coin mechanism
4. Press again the pushbutton B

N.B. If the procedure is not correctly carried out, you can find wrong values in commands 09 - 10.

11 CALIBRATION AND ADJUSTMENTS



This section is for qualified assistance staff only

11.1 ADJUSTING THE INSTANT BEVERAGES

The solenoid valve opening times and the quantity variations (in grams) of the instant products, can be adjusted by setting the desired parameters during the programming phase in the: "RECIPE DOSE SETTING" item (command 51).

11.2 ADJUSTING THE ESPRESSO COFFEE

The quantity of water can be adjusted by setting the desired parameter during the programming phase at THE "RECIPE DOSE SETTING" item (command 51). Whereas to change the quantity of ground coffee and the degree of grinding, see the paragraph on "ESPRESSO COFFEE CALIBRATION".

11.3 ESPRESSO COFFEE CALIBRATION

ADJUSTMENT OF GRINDING:

Grinding degree can be adjusted by means of the plastic nut placed between grinding unit and coffee canister (pos.G).

Adjusting must be made when grinding unit is working.

- For a finer ground rotate knob "G" so that ring nut "M" rotates clockwise.

After completing the adjustment phase, always carry out 3 or 4 vending cycles to allow the coffee bean-size distribution to stabilise.

GROUND COFFEE DOSE:

The amount of ground coffee dosed out for an espresso coffee can be set between 6.5 (± 0.2) and 8.5 (± 0.2) grams according to the position of the volumetric canister (det.J). To check the weight of the dose, remove the espresso unit, and execute Service 07 followed by Service 08 (see Command 52). Remove and replace the espresso unit as described in paragraph SPECIAL MAINTENANCE, CLEANING OF COFFEE UNIT FILTERS.

GROUND COFFEE COMPRESSION ADJUSTMENT:

The pressing element support has 4 positions (A B C D) for varying the compression of the dose according to the set quantity of grams. Remove the seal ring (det.K), slightly pull out the pressing element (det.L) and rotate it to the desired position.

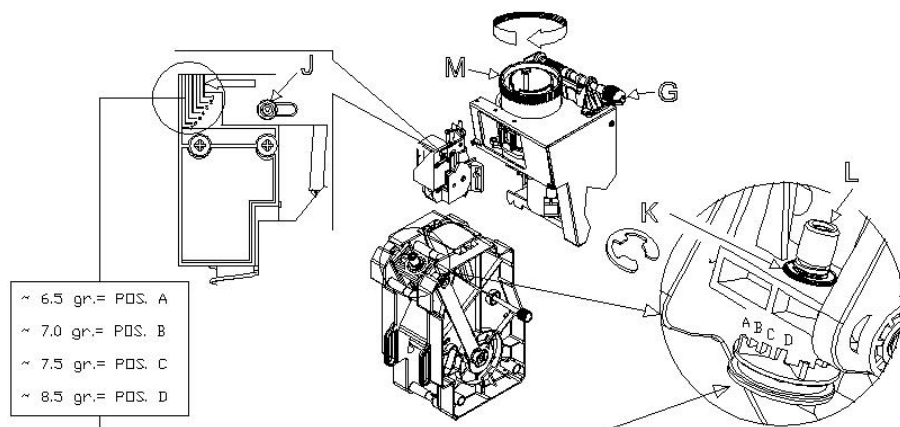

12 HEALTH AND HYGIENE RULES

It is indispensable to carry out thorough cleaning and sanitization of all the parts which come into contact with foodstuffs, upon installation of the distributor and weekly thereafter, in compliance with the health and hygiene regulations in force, and that is:

- The mixing groups and product distribution pipes
- Distributor spouts
- Product containers
- Cup stands
- Sugar dispenser

Remove the above-mentioned parts and wash them carefully with detergent products, following the indications shown on the label of the product used.

Any residues of detergent, disinfectant and foodstuffs should be removed using a moist sponge before putting the vending machine into service. Rinse thoroughly in order not to leave traces of the solution used.

Do not wash the vending machine with direct and/or high pressure water jets.

13 MAINTENANCE

	<p>When the door is open, the protected terminal block of the power cable and the wires which connect it to the door safety switch are live. Complete insulation from the electricity mains is only obtained by turning off the external switch. Therefore all the operations which require the vending machine to be powered with the door open must be carried out only by qualified personnel informed of the specific risks which this condition entails.</p>
---	---

13.1 GENERAL MAINTENANCE

Adequate recurring maintenance of machine grants its reliability in operation.

This section describes the required maintenance operations and their frequency which has however to be considered as indicative since it depends upon various factors such as calcium content of water, kind of products, climatic conditions and, especially, humidity.

The operations described in this section do not exhaust all maintenance operations.

During maintenance vending machine has to be switched off.

Do not wash vending machine with direct jets of water and high pressure.

Clean carefully stainless steel and painted surfaces in order to avoid oxidation or chemical etching. Do not use toxic detergent substances.

13.2 BASIC MAINTENANCE

WITH EVERY FILLING OPERATION it is necessary:

- To thoroughly clean the soluble drink mixing units (pos. 1), the distributor spouts (pos. 2), and the cup stand, and dry them before putting them back in place.
- Drain and wash the liquid waste container (pos. 3) and replace the coffee dregs bag.
- Clean the distributor in general.

	<p>After cleaning, check that the tubes attached to the dispensing arms are not blocked or squashed during the beverage dispensing phase.</p> <p>Remove the above-mentioned parts and wash them carefully with detergent products, following the indications shown on the label of the product used. Any residues of detergent, disinfectant and foodstuffs should be removed using a moist sponge before putting the vending machine into service. Rinse thoroughly in order not to leave traces of the solution used.</p> <p>Do not wash the vending machine with direct and/or high pressure water jets.</p>
---	---

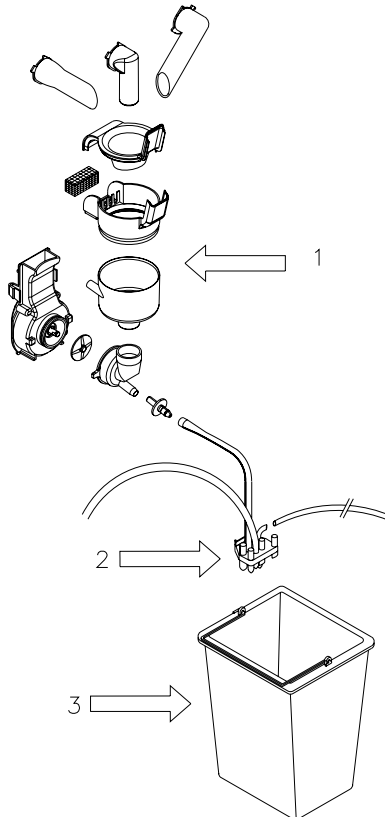

13.3 SPECIAL PERIODIC MAINTENANCE



This chapter is for special maintenance staff only

EVERY 2,000 DELIVERIES:

- Check the gaskets on the mixer units for signs of wear.
- Check the quantity/quality of the beverages.
- Check the gaskets on the espresso coffee unit for signs of wear.
- Check the degree of grinding.
- Check that the front piston and its vent are clean.

EVERY 5,000 DELIVERIES:

- Clean the coffee unit filters.

The duration of the grinder depends on the quality of the coffee and degree of grinding required.

The grinder will need replacing between 30,000 and 50,000 cycles based on these factors:

- 1) Increased grinding time
- 2) Overheating particularly on the hopper support collar
- 3) Powder residues on the bottom of the cup

We recommend adjusting the grinders before deciding to replace them.

Foreign material can damage the grinders and/or motor beyond repair.

EVERY MONTH:

- Disinfect all the parts that come into contact with foodstuffs.

EVERY SIX MONTHS:

- Ensure that no lime scale deposits have formed, especially in the boiler; if they have, replace it.
- Carefully clean the suction pipe.

ONCE A YEAR:

- Replace the plastic components of the mixing units.
- Replace the beverage dispenser tubes.

13.4 SPECIAL MAINTENANCE, CLEANING OF COFFEE UNIT FILTERS  

Switch off the machine by means of the main switch.

Pull off the coffee dispenser tube from the arms.

Pull off the water inlet tube by unscrewing the ring nut (det.1).

Unscrew the knob and remove the unit from the support (det.2).

Remove the hopper from its seat (det.3).

Turn the lever to bring the infusion chamber to the position where the piston is extended as far as possible (det.4).

Remove the sealing rings, pull out the shafts from the pins, in order to extract the pressing element support (det.5).

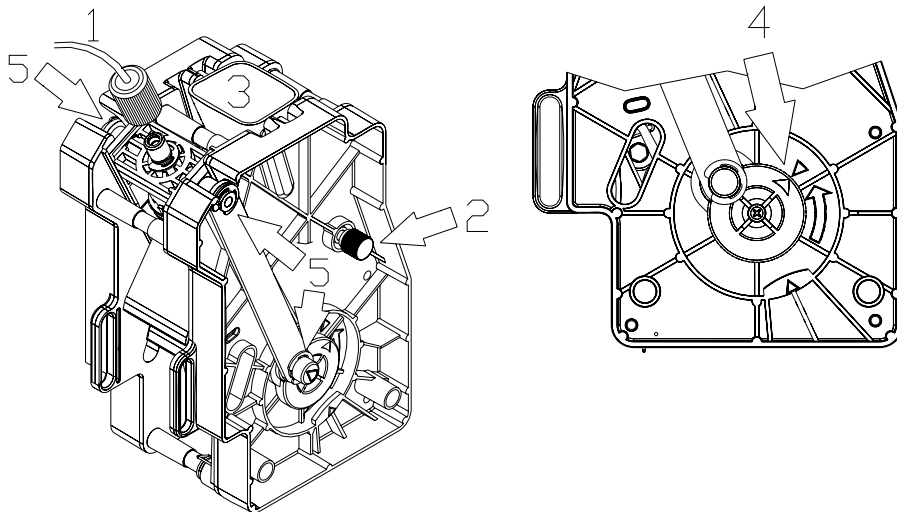

Remove the top filter by removing the setscrew (det.6).

Remove the bottom filter by unscrewing the setscrew (det.7).

Immerse the whole unit in a cleaning solution and let it soak for approx. twenty minutes.

Carefully wash and dry all the parts with hot water and ensure that all the elements through which the coffee passes and the pressing element vents are clean.

If necessary, replace the gaskets and filters.

With the infusion chamber still in the position where it is extended as far as possible, remount the bottom filter.

Remount the pressing element support.

Attach the unit to the support and screw on the knob making sure that the joint of the ratiomotor is correctly centred (det.8).

Remount the coffee dispensing tube and the water inlet tube.

Switch on the vending machine. Execute two or three washing cycles before loading any of the beverage products in Service 6 mode (see Command 52).

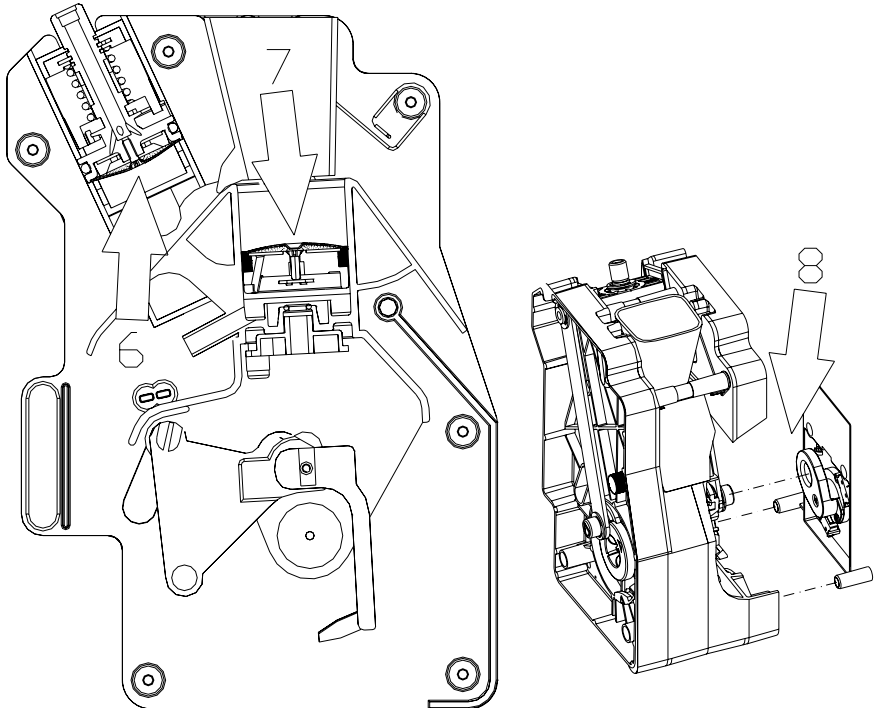

13.5 PROCEDURE FOR DRAINING AIR-BREAK AND BOILER WATER (SERVICE 16 AND 17)

(only on espresso models)



This chapter is for special maintenance staff only

The purpose for draining the water from the boiler is mainly to prepare the vending machine for safe transportation or storage. In fact, the water is eliminated to prevent the risk of it spilling onto the electrical parts and the risk of the boiler freezing.

The procedure is as follows:

1. Open the door and insert the key in the safety lock.
2. Access the programming mode.
3. Enter the number "52" to access the services mode and press ENTER.
4. Enter the number "16" to start the air-break emptying procedure and press ENTER.

At this point the water delivery to the air-break and the heating element of the boiler are automatically disabled.

A coffee unit washing cycle begins: the purpose of this cycle is to empty the air-break and cool the boiler.

5. Open the espresso unit support panel to access the pressure boiler.
6. Caution: the external temperature of the boiler could be very high. Burn hazard!
7. Unscrew the water inlet union and slide out the tube situated at the bottom of the boiler.
8. Replace the tube on the union with a plastic tube and prepare a container to collect the water from the boiler.
9. Enter the number "17" to start the boiler emptying procedure and press ENTER.

Nota bene

Beware of the electrical parts near the boiler. Place the container for the collection of the water away from the electrical parts.

- Remove the vending machine ignition key. Remove the tube applied to the coupling of the espresso boiler. Mount the union. Clean and dry the vending machine of any traces of water which may have formed during the procedure. Close the espresso unit support panel. Close the machine.
- At the end of the operation cut off the connection of the JP11 supply connector of the boiler heating element;

If necessary, restart the appliance following the instructions given in the "PLACING INTO SERVICE" section.

14 ALARMS



This chapter is for qualified assistance staff only

Vending machine can point out some possible bad functionings. The "TEST VEND" function is also used to display any alarms existing in the machine. Press the "B" (ENTER) key to scroll the list (if one exists) and at the end a message appears asking : "CLEAR DATA?". Press "B" (ENTER) to confirm and to eliminate all the alarm conditions, otherwise press "A" (ESC).

N°	ALARM	TIMEOUT (sec.)	FAILURE	SOLUTION
02	Waste leve	5	max.waste level reached	<ul style="list-style-type: none"> • drain waste bin • <u>check correct functioning of microswitch (CLR)</u>
03	Water missing	30	water supply missing	<ul style="list-style-type: none"> • check correct opening of outer tap • check that there is no contraction in the inlet hose • check correct functioning of the inlet valve
04	Cup Holder Empty	120	cups are missing (still 3 deliveries are available during turret change	<ul style="list-style-type: none"> • load cups • check correct functioning of microswitch (CPB) • check correct functioning of the turret gear motor
05	Dispensing Arm Error	8	dispensing heads are not in delivery position	<ul style="list-style-type: none"> • a cup blocks heads • check correct functioning of heads gear motor • <u>check correct functioning of microswitch (CDB)</u>
05	Dispensing Arm Error	8	dispensing heads are not in non-working position	<ul style="list-style-type: none"> • a cup is blocked in the heads • check correct functioning of heads gear motor • <u>check correct functioning of microswitch (CDB)</u>
06	Sugar/stirrer dispenser	3	Sugar dispenser microswitch does not commute at the starting.	<ul style="list-style-type: none"> • Check correct functioning of sugar dispenser microswitch • Check that the sugar dispenser microswitch commutates correctly • Sugar hose is not introduced correctly
06	Sugar/stirrer dispenser	10	Sugar dispenser has not finished the rotation.	<ul style="list-style-type: none"> • Check that the sugar dispenser microswitch commutates correctly • Sugar hose is not introduced correctly

N°	ALARM	TIMEOUT (sec.)	FAILURE	SOLUTION
07	Coffee unit	2	The unit control micro does not switch over when it passes from the open unit position to the closed unit position.	<ul style="list-style-type: none"> Remove the coffee unit and Check that the motor idle correctly. If there are any inconveniences, Check that the coffee unit is not clogged or broken. Otherwise, if there are some inconveniences, you have to: Check the correct calibration of the cam of coffee unit microswitch Check that the coffee unit microswitch commutes correctly Check the correct functioning of gear motor
08	Coffee meter	variable	The coffee meter microswitch does not change condition after having delivered the grounded coffee dose.	<ul style="list-style-type: none"> Coffee meter is clogged Check that coffee meter microswitch commutes correctly
09	Pump start	5	The unit does not reach the dispensing position or unit closed position.	<ul style="list-style-type: none"> Remove the coffee unit and Check that the motor idle correctly. If there are any inconveniences, Check that the coffee unit is not clogged or broken. Otherwise, if there are some inconveniences, you have to: Check the correct calibration of the cam of coffee unit microswitch Check that the pump microswitch commutes correctly Check the correct functioning of gear motor
10	Delivery timeout	2	The impulse time counted by the volumetric meter exceeds the timeout.	<ul style="list-style-type: none"> Check the fan. The coffee unit filter is clogged. Check the water pump. Check the drink dispenser tubes.
11	Coffee unit	10	The unit does not move to open position.	<ul style="list-style-type: none"> Remove the coffee unit and Check that the motor idle correctly. If there are any inconveniences, Check that the coffee unit is not clogged or broken. Otherwise, if there are some inconveniences, you have to: Check the correct calibration of the cam of coffee unit microswitch Check that the pump microswitch commutes correctly Check the correct functioning of gear motor

N°	ALARM	TIMEOUT (sec.)	FAILURE	SOLUTION
12	Grinding timeout	variable	programmed grinding maximum time has been passed.	<ul style="list-style-type: none"> The coffee is finished Check the correct functioning of coffee grinder motor Check that coffee meter microswitch commutes correctly
13	Espresso coffee unit not installed correctly			<ul style="list-style-type: none"> Check the position of the coffee unit. Check that the coffee unit detection microswitch (CPGC) is working.
14	Cup dispenser with photocell error	variable		
15/ 16	Probe temperature		The machine detects an excessive water temperature in the boiler	<ul style="list-style-type: none"> Check the probe temperature
17	Delivery timeout (selections with hot instant beverages)	2	The impulse time counted by the volumetric meter exceeds the timeout.	<ul style="list-style-type: none"> Check the fan. Check the water pump. Check the drink dispenser tubes.
19	Cup unit microswitch	12	The cup unit microswitch doesn't finish the rotation	<ul style="list-style-type: none"> Check correct functioning of the cups gearmotor
20	Wrong dose.		The water passage inside the espresso unit is blocked	<ul style="list-style-type: none"> Check the dose and the grain size of the ground coffee Clean the espresso unit Clean or replace the inlet and outlet tubes of the espresso unit
21	Pump microswitch	0	Pump microswitch control with coffee unit in dispensing position.	<ul style="list-style-type: none"> High dose coffee High pressure coffee water Check the correct calibration of the cam of coffee unit microswitch Check the correct functioning of pump microswitch
22	Pump microswitch	0.	Pump microswitch control with coffee unit in stand position.	<ul style="list-style-type: none"> High dose coffee High pressure coffee water Check the correct calibration of the cam of coffee unit microswitch Check the correct functioning of pump microswitch
23	Cup unit microswitch	1	The cup unit microswitch doesn't work at the departure	<ul style="list-style-type: none"> Check correct functioning of the cups gearmotor Check correct functioning of the cups microswitch (CMB)
30	Payment system out of service.			<ul style="list-style-type: none"> Coin mechanism disconnected Coin mechanism not energised Coin mechanism broken
32	Interrupted communication between main board and power board			<ul style="list-style-type: none"> Check the connection to the boards Check the condition of the connecting cables Possible breakage of one of the two boards

15 TABLES FOR MACHINE MODEL CONFIGURATION (COMMAND 50) 

Several examples of machine model setup follow that show, in order, the position of the selection labels and the powder canister labels. As there cannot be an exact correspondence between the selection names for each country and the labels, general descriptions only are provided.

Espresso Vending Machine E6

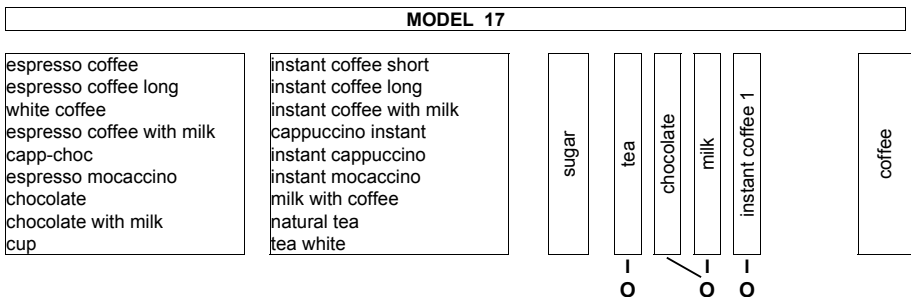
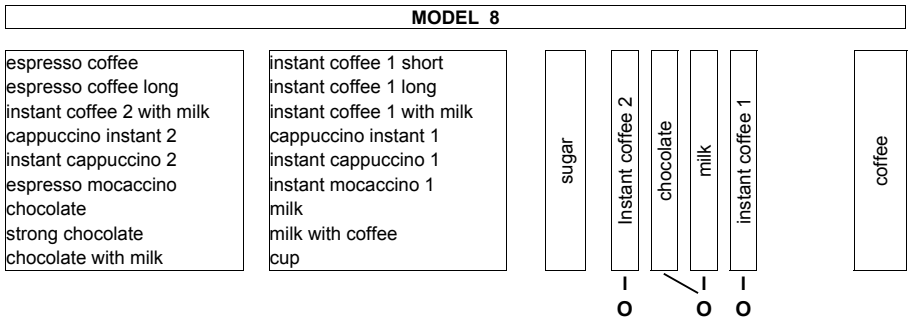
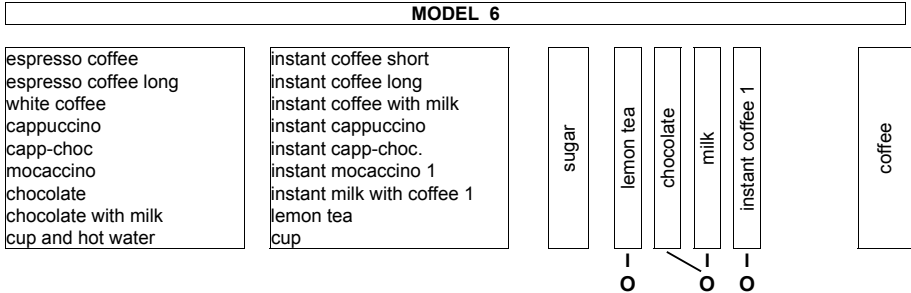

MODEL 25

selection 1
selection 2
selection 3
selection 4
selection 5
selection 6
selection 7
selection 8
selection 9

selection 10
selection 11
selection 12
selection 13
selection 14
selection 15
selection 16
selection 17
selection 18

sugar

powder 1

powder 2

powder 3

powder 4

coffee

O

O

O

MODEL 30

espresso coffee
espresso coffee long
white coffee
cappuccino
capp-choc
mocaccino
chocolate
chocolate with milk
cup and hot water

instant coffee short
instant coffee long
instant coffee with milk
instant cappuccino
instant capp-choc.
instant mocaccino 1
instant milk with coffee 1
lemon tea
cup

sugar

lemon tea

instant coffee 1

chocolate

milk

coffee

O

O

O

O

Distributori Espresso E7

MODEL 1

espresso coffee
 espresso coffee long
 white coffee
 cappuccino
 capp-choc
 mocaccino
 barley coffee
 barley coffee with milk
 cup and hot water

instant coffee short
 instant coffee long
 instant coffee with milk
 instant cappuccino
 instant capp-choc.
 mocaccino
 chocolate
 lemon tea
 cup

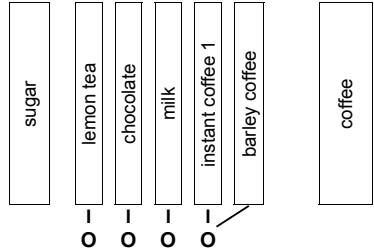

MODEL 2

espresso coffee
 espresso coffee long
 white coffee
 cappuccino
 capp-choc
 milk with coffee
 milk
 chocolate
 chocolate with milk

instant coffee short
 instant coffee long
 instant coffee with milk
 instant cappuccino
 instant capp-choc.
 barley coffee short
 barley coffee with milk
 barley cappuccino
 lemon tea

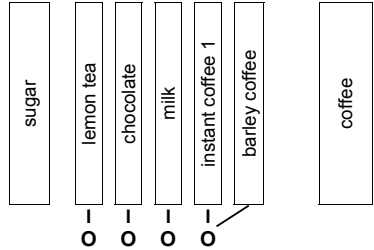

MODEL 3

espresso coffee
 espresso coffee long
 instant coffee 1 with milk
 instant cappuccino 1
 instant capp-choc. 1
 instant mocaccino 1
 american coffee
 chocolate with milk
 cup and hot water

barley coffee short
 barley coffee long
 barley coffee with milk
 barley cappuccino
 milk
 milk with coffee
 lemon tea
 chocolate
 cup

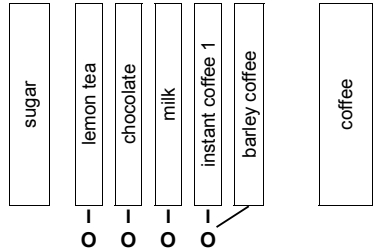

MODEL 4

espresso coffee
 espresso coffee long
 white coffee
 espresso coffee with milk
 capp-choc
 mocaccino
 chocolate
 chocolate with milk
 lemon tea

instant coffee short
 instant coffee long
 instant coffee with milk
 cappuccino instant
 instant capp-choc.
 instant mocaccino
 milk with coffee
 soup
 cup

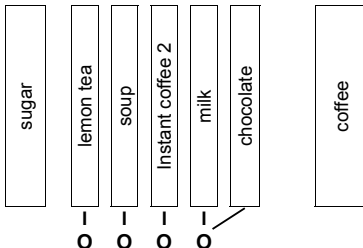
**MODEL 5**

espresso coffee
 espresso coffee long
 white coffee
 espresso coffee with milk
 capp-choc
 mocaccino
 chocolate
 natural tea
 lemon tea

instant coffee short
 instant coffee long
 instant coffee with milk
 cappuccino instant
 instant cappuccino
 instant mocaccino
 milk with coffee
 tea withe
 cup

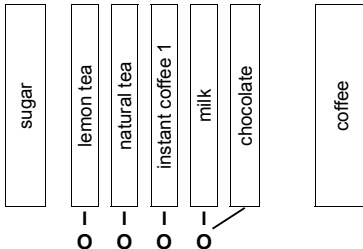
**MODEL 29**

selezione 1
 selezione 2
 selezione 3
 selezione 4
 selezione 5
 selezione 6
 selezione 7
 selezione 8
 selezione 9

selezione 10
 selezione 11
 selezione 12
 selezione 13
 selezione 14
 selezione 15
 selezione 16
 selezione 17
 selezione 18

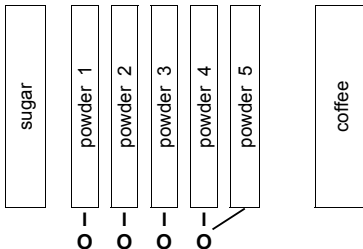

Distributori Instant 17

MODEL 12

instant coffee 1 short
 instant coffee 1 long
 instant coffee 1 with milk
 instant cappuccino 1
 instant capp-choc. 1
 instant mocaccino 1
 milk with coffee
 chocolate
 chocolate with milk

instant coffee 2 short
 instant coffee 2 long
 instant coffee 2 with milk
 instant cappuccino 2
 instant capp-choc. 2
 instant mocaccino 2
 lemon tea
 soup
 cup

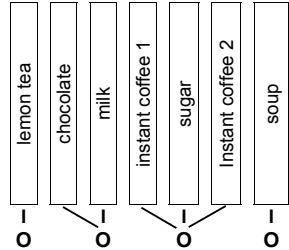

MODEL 20

espresso coffee no sugar
 black coffee no sugar
 white coffee no sugar
 cappuccino no sugar
 mocaccino no sugar
 white te no sugar
 white coffee 2 no sugar
 white coffee 2 no sugar
 cup and hot water

espresso coffee
 black coffeer
 white coffee
 cappuccino
 mocaccino
 white te
 lemon tea
 chocolate
 strong chocolate

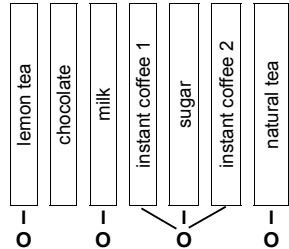

MODEL 21

instant coffee 1 short
 instant coffee 1 long
 instant coffee 1 with milk
 cappuccino instant 1
 instant capp-choc. 1
 instant mocaccino 1
 milk with coffee
 chocolate
 chocolate with milk

instant coffee 2 short
 instant coffee 2 long
 instant coffee 2 with milk
 cappuccino instant 2
 instant cappuccino 2
 instant mocaccino 2
 lemon tea
 tea white
 cup

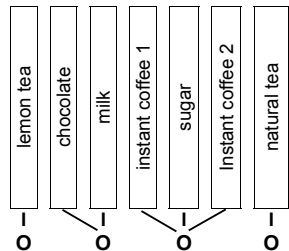

BLANK PAGE FOR POSSIBLE NOTES

BLANK PAGE FOR POSSIBLE NOTES

**SEDE PRINCIPALE / HEAD OFFICE / SIÈGE SOCIAL
HAUPTBÜRO / OFICINA CENTRAL**

FAS INTERNATIONAL SPA
Via Lago di Vico, 60
36015 SCHIO - Vicenza - Italy
Phone +39 0445 5022011 - Fax +39 0445 502010
info@fas.it

FILIALI / SUBSIDIARIES / FILIALES / FILIALEN / FILIAL

FAS INTERNATIONAL S.L. - BARCELONA
C / BEATO ORIOL, 1
PLANTA 1ª OFICINA 3
EDIFICIO FORUM MONTCADA
08110 MONTCADA I REIXAC - Barcelona
Phone 0034 93 5647856 - Fax 0034 93 5754034
fas@es.fas.it

FAS FRANCE S.a.r.l.
11, Rue de la Grande Borne
77990 LE MESNIL AMELOT - Paris - France
Phone +33 1 60 03 36 46 - Fax +33 1 60 03 95 21
fas@fr.fas.it



UNI EN ISO 9001:2000
N° 9190 FASI



N° IT 8691

FAS International S.p.A. reserve the right to change without notice the technical features of this publication and refuse all responsibility for possible inexactness, due to print mistakes, in the publication.